



ONE WORLD • ONE TEAM • ALL GASES

2024

**MAKEEN**  
ENERGY

**EQUIPMENT**  
FOR LPG, LNG AND INDUSTRIAL GASES

COMPLETE RANGE



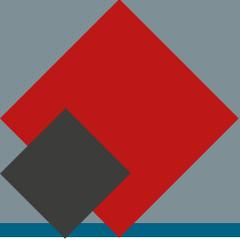

<b>LPG</b>	<b>A</b>	Compressors	<b>4</b>
	<b>B</b>	Pumps	<b>15</b>
	<b>C</b>	Dispensers LPG • Refueling stations LPG	<b>26</b>
	<b>D</b>	Measurement LPG	<b>41</b>
	<b>E</b>	Vaporizers LPG	<b>57</b>
	<b>F</b>	Accessories for road tankers	<b>69</b>
	<b>G</b>	Shut-off, bypass, 3-way, solenoid, ball, quick-acting valves	<b>78</b>
	<b>H</b>	Pressure regulators • Safety shut off valves	<b>90</b>
	<b>I</b>	Safety relief valves	<b>95</b>
	<b>J</b>	Excess flow valves • Back check valves (non return valves)	<b>97</b>
	<b>K</b>	Filling, quick-acting filling valves • Unloading adaptors • Fittings	<b>101</b>
	<b>L</b>	Strainers • Traps • Fine filters • Methanol Dewatering equipment	<b>108</b>
	<b>M</b>	Fittings for refilling facilities • Swivel joints • Loading arm stations	<b>112</b>
	<b>N</b>	Electrical components • Gas alarms systems	<b>118</b>
	<b>O</b>	Connections parts	<b>119</b>
<b>INDUSTRIAL</b>	<b>A</b>	Compressors	<b>122</b>
	<b>B</b>	Pumps	<b>127</b>
	<b>C</b>	Measurement	<b>135</b>
	<b>D</b>	Road tanker equipment	<b>136</b>
<b>ALTERNATIVE FUEL</b>	<b>A</b>	Refueling stations LNG, L-CNG	<b>138</b>
	<b>B</b>	Regasification units	<b>140</b>
	<b>C</b>	DME Dispensers and refuelling	<b>142</b>
	<b>D</b>	Tanks	<b>143</b>
	<b>E</b>	Road tanker equipment	<b>144</b>
	<b>F</b>	CRYO equipment	<b>146</b>

## Important Notes

The appearance and the disposition of elements and components may be different from the illustrations. The manufacturer retains the right to execute some technical changes without any prior advertising without any influence on the quality of the products.

**CAUTION!**  
Hydrocarbon gases and refinery products are flammable products! Danger of freezing!  
Installation and servicing have to be carried out by qualified personnel only.

Professionals have to be trained and qualified especially to work with the equipment for flammable gases and liquids. The operation with liquefied gas installations is only permitted, if every safety rule and regulation is strictly observed and considered .

Please read and follow all instructions, guidelines and rules as per description in the accompanying documents. The guarantee obligations will be invalid in case of contempt against rules and instructions . The manufacturer resumes no liability for damages which were a result of the improper use of the installations.

### **DISCLAIMER**

The information of this catalogue are compiled with utmost care and according to current knowledge. However company FAS resumes no warranty for accuracy, completeness and actuality of the contents. All written texts and stated dimensions in this catalogue are non-binding. The graphics and illustrations are exemplary. Construction and design changes are expected.

# FAS MAKEEN ENERGY COMPANY



**Flüssiggas Anlagen GmbH (FAS), established in 1975, specializes in the development and production of technological equipment for the oil and gas industry.**

In 2024 and onwards, FAS relies on a global team of more than 3,000 highly skilled experts.

What positive effects does this have for our customers?

- prime delivery times
- high level of service performance
- substantial engineering assistance

This catalog includes a part of our product and supply program and covers the following areas:

- equipment for the Liquefied Petroleum Gas (LPG, propane-butane mixtures)
- compressor and pump units for technical gases and industrial liquids
- mixing units for natural gas substitution
- equipment for the Liquefied Natural Gas (LNG) in the form of autonomous gas supply units

50,000 nomenclature items for the oil and gas industry

Implementation of major projects for the world's leading fuel and energy companies

Professional customer support online

Many years of cooperation with the world's leading manufacturers

In the face of global changes and the ever-evolving energy landscape, it's time for FAS to explore new horizons. Our company has undergone a significant transformation: FAS is now firmly integrated into the **MAKEEN Energy Group**. This marks the beginning of a new chapter, one filled with both opportunities and challenges.

The amalgamation with **MAKEEN Energy Group** enables us to provide customized, cost-efficient, and energy-efficient solutions, which not only better serve the needs of our current customers but also attract new clients. As a result, we can effectively address upcoming changes in the energy sector through our large-scale projects.

Through our integration, we've established a broader and more stable foundation for realizing our shared visions. Simultaneously, we can benefit from our existing infrastructure, which includes state-of-the-art and generously sized production facilities, an extensive industrial equipment parts inventory, and a proven quality assurance system. This allows us to support our customers even more efficiently and to design innovative solutions for the energy sector of tomorrow.



## A

## Compressors

## Dry run piston compressor

- vertical execution
- oil-free dry run piston compressor
- V-belt drive
- air cooler
- suction and pressure gauge

FAS No.	Type Corken	Max. capacity (m <sup>3</sup> /h)
21 050	91	13
21 054	291	27
21 055	491	60
21 056	691	102
21 0595	891	200
FAS No.	Type Blackmer	Max. capacity (m <sup>3</sup> /h)
21 1001	091	14
21 104	161	26
21 105	361	58
21 106	601	100
21 097	942	200

## Compressor units

- for LPG road tankers, for LPG transfer and and mobile evacuation LPG vapor
- complete with 4-way ball valve and OMS 80 hydraulic motor
- without support frame

FAS Nr	Type	Positioning of ball valve
21 0235	FAS CORKEN STW 291	front
93 0607		side
93 060	FAS BLACKMER STW 161	front
93 0605		side



Compressor unit with front ball valve

Compressor unit with side ball valve

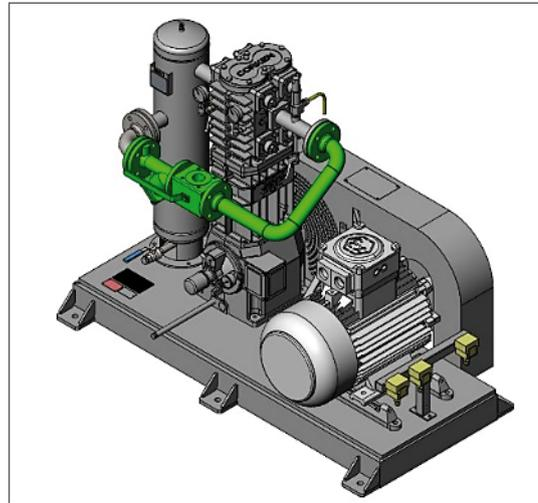
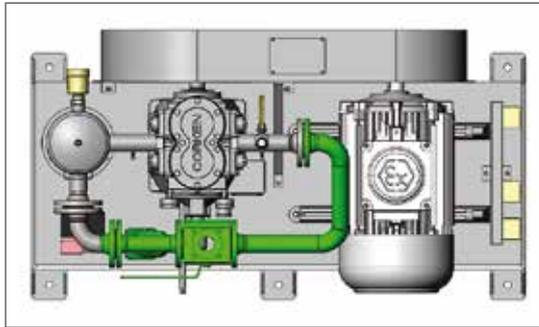

Compressor unit Type FAS

№	Compressor unit type FAS-CORKEN	91	291	491	691	891	HG	
	Compressor unit type FAS-BLACKMER	-	161	361	601	942	-	
	Capacity, m <sup>3</sup> /h	14	28	61,2	103,3	200	375	
1	Compressor unit consisting of: compressor CORKEN, base plate, gas trap, electrical motor, V-belt drive, safety relief valve	21 0141	21 0930	21 0952	21 0640	21 8201	46 300	
2	Compressor unit consisting of: compressor Blackmer, base plate, gas trap, electrical motor, V-belt drive, safety relief valve	-	21 0974	21 0972	21 0973	21 0975	-	
3.1	Four-way ball valve, strainer incl. Pipe line DN 50 PN 40	21 0142	21 0932	21 0953	21 0641	21 8202	14 018*	
3.2	Buffer tank	-	-	-	-	93 9856	-	
3.3	Min. oil pressure switch – 1 pc. per compressor unit	18 4573 (EU) / 18 462 (CIS)						
3.4	Max. pressure switch, (pressure side) – 1 pc. per compressor unit	18 4563 (EU) / 18 456 (CIS)						
3.5	Min. pressure switch (suction side) – 1 pc. per compressor unit	18 4573 (EU) / 18 457 (CIS)						
3.6	Level sensor, type Liquiphant FTL41 – 1 Stk. per compressor unit	26 1356						
3.7	Resistance thermometer PT 100 – 1 Stk. per compressor unit	26 312						
3.8	Welding thermometer well for PT 100 – 1 Stk. per compressor unit	26 316						
3.9	Bracketry for mounting of pressure switches – 1 Stk. per compressor unit	21 195						
4	Electrical control box for installation inside the building and outside of protection zone	26 932						463206
4.1	Isolating amplifier, type of protection – EEx ia II C – 2 pcs.* per compressor unit	26 3020						
4.2	Process transmitter Ex for PT 100 – 1 pc. per compressor unit	26 3144						
5	Flexible hose PN 40, stainless steel, L=1000 mm on both sides lapped flanges – 2 pcs. per compressor unit	-	21 175	21 191	21 192	21 193	82739	

\*Attention! The quantity of item 2.1 depends on the quantity of items 1.3-1.6. 2 devices require 1 unit of item 2.1.

\*\*HG compressors are equipped with one strainer only.



### FAS 46 300 horizontal compressor unit Type FAS-Corken HG 601 BB

- medium – LPG
- cylinder number/stage number – 2/1
- capacity – up 375 Nm<sup>3</sup>/h
- min. inlet pressure – 0,5 bar
- speed – 1100 U/min
- with pressure monitoring system (gas/oil), liquid gas trap, strainer, four-way ball valve, safety relief valve (adjustable), V-belt drive with protection plate
- 3-phase motor with a capacity of: 58 kW, EEx IICT3, 400/690 V, 50 Hz

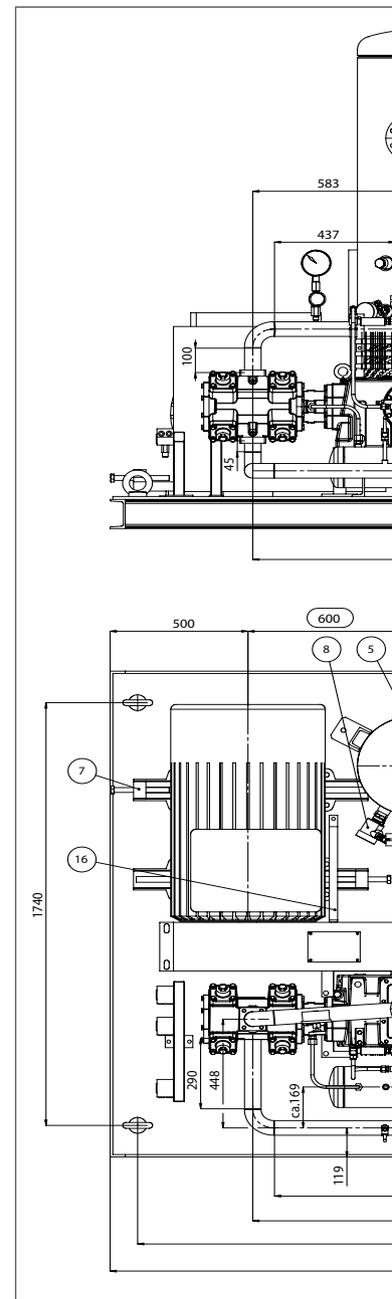



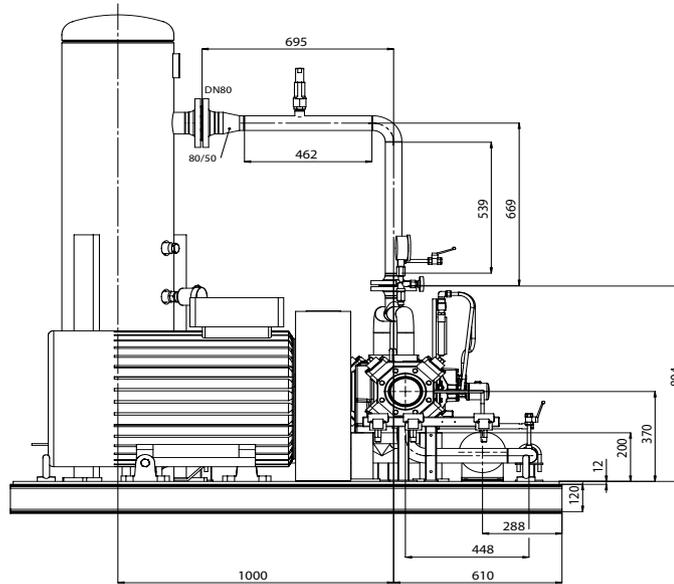
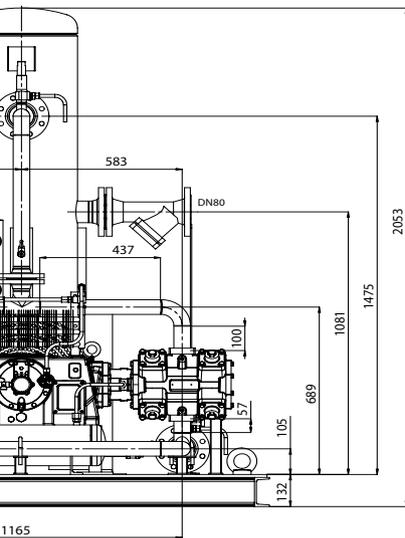

Dimensional drawing for FAS 46 300  
horizontal compressor unit Type  
FAS-Corken 601

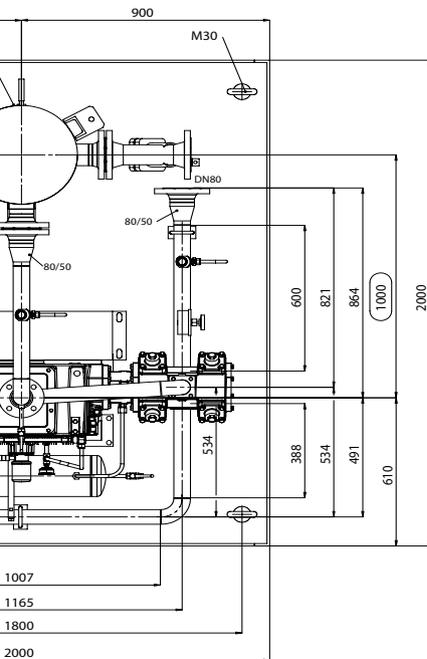

**Mobile compressor unit**

- for use in Ex zone
- dry running piston compressor unit with three phase motor 400/690 V in EX-execution
- with pressure monitoring and safety fittings
- Ex-control unit for three phase motor with 30 m connection cable
- 2 LPG hoses a` 12 m with shut-off valves
- mounted on a light ground plate, grounded and painted, mounted on a hand cart (up to 60 km/h)

*Additional equipment for liquid phase: high pressure hoses, sight flow indicator, strainer, valves. Can be designed on a base frame for the mounting in a car.*



Compressor Type		161	161	361	361	601
			291		491	691
FAS No.		21221	21093	21223	21223/21095	21226/21064
Connection	Compressor (NPT IG)	¾"	¾"	1¼"	1¼"	1½"
	Unit (flange DN)	20	25	32	32	40
Cylinder number		2	2	2	2	2
Piston stroke, mm		63	63	76	76	102
Max. capacity, m³/h		26	26	58	58	100
Min. inlet pressure, bar		0,21	0,21	0,21	0,21	0,21
Max. outlet pressure, bar		24,1	24,1	20,7	22,4	24,1
Speed, U/min <sup>-1</sup>		790	790	790	790	770
Max. approved consumption of electricity, kW		8,0	8,0	15,0	15,0	30,0
Motor capacity, kW		5,0	5,0	10,0	10,0	17,5
Weight of compressor, kg		104	104	153	153	322
Weight of complete compressor unit, kg		140	265	214	400	630

### Mobile compressor unit

- for use in Ex zone
- dry running piston compressor unit with Diesel motor Hatz 1D81Z for Ex-protection area
- with pressure monitoring and safety fittings
- 2 LPG hoses l=12 m
- mounted on a light base construction, primed and painted, mounted on a trailer (up to 60 km/h)

*Additional equipment for liquid phase: high pressure hoses, sight flow indicator, strainer, valves. Can be designed on a base frame for the mounting in a truck.*

FAS No.		933930
<b>Compressor Type</b>		<b>291</b>
Connection	Compressor (NPT IG)	3/4"
	Unit (flange DN)	25
Cylinder number		2
Piston stroke, mm		63
Max. capacity, m <sup>3</sup> /h		26
Min. inlet pressure, bar		0,21
Max. outlet pressure, bar		24,1
Speed, U/min <sup>-1</sup>		790
Max. approved consumption of electricity, kW		8,0
<b>Motor Type</b>		<b>Hatz 1D81Z</b>
Cylinder number and capacity, l		1/0,67
Compression grade		20,5
Max. motor capacity (3000 U/min <sup>-1</sup> ), kW		10,3
Fuel consumption (2000 U/min <sup>-1</sup> ), g/kW•h		240

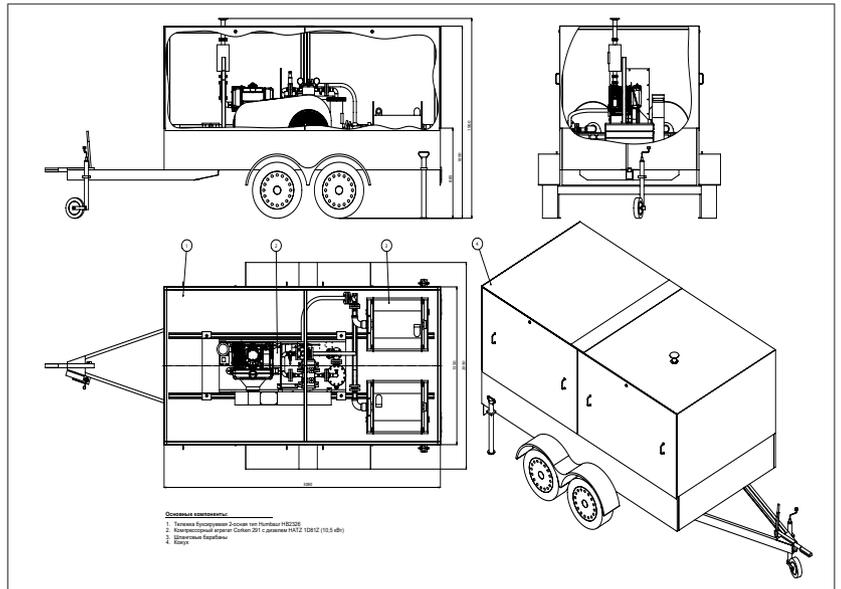

*Dimensional drawing of mobile compressor unit with diesel motor drive*

**Complete pump-compressor station**

for transferring of propane / butane from tankers, rail tanks and road tankers. "Ready to use" design including all necessary pipe lines, process and safety equipment.

Available with all types and numbers of pumps and compressors.

**Example versions:**

- FAS 93 374 – 3 compressor units 200 m<sup>3</sup>/h each, 2 pump units 40 m<sup>3</sup>/h and 18 m<sup>3</sup>/h
- FAS 93 3740 – 4 compressor units 200 m<sup>3</sup>/h each, 2 pump units 40 m<sup>3</sup>/h each
- FAS 93 3748 – 4 compressor units 200 m<sup>3</sup>/h each, 4 pump units 40 m<sup>3</sup>/h each (see drawing below)
- FAS 93 3733 – 2 compressor units 100 m<sup>3</sup>/h each, 3 pump units 18 m<sup>3</sup>/h each
- FAS 93 3740 – 4 compressor units 100 m<sup>3</sup>/h each, 4 pump units 40 m<sup>3</sup>/h each

Other versions are available on request.

**Inlet/Outlet**

Pump group	Inlet:	DN 150
	Outlet	DN 80
	Bypass line	DN 65
Compressor group	Inlet:	DN 80
	Outlet	DN 100

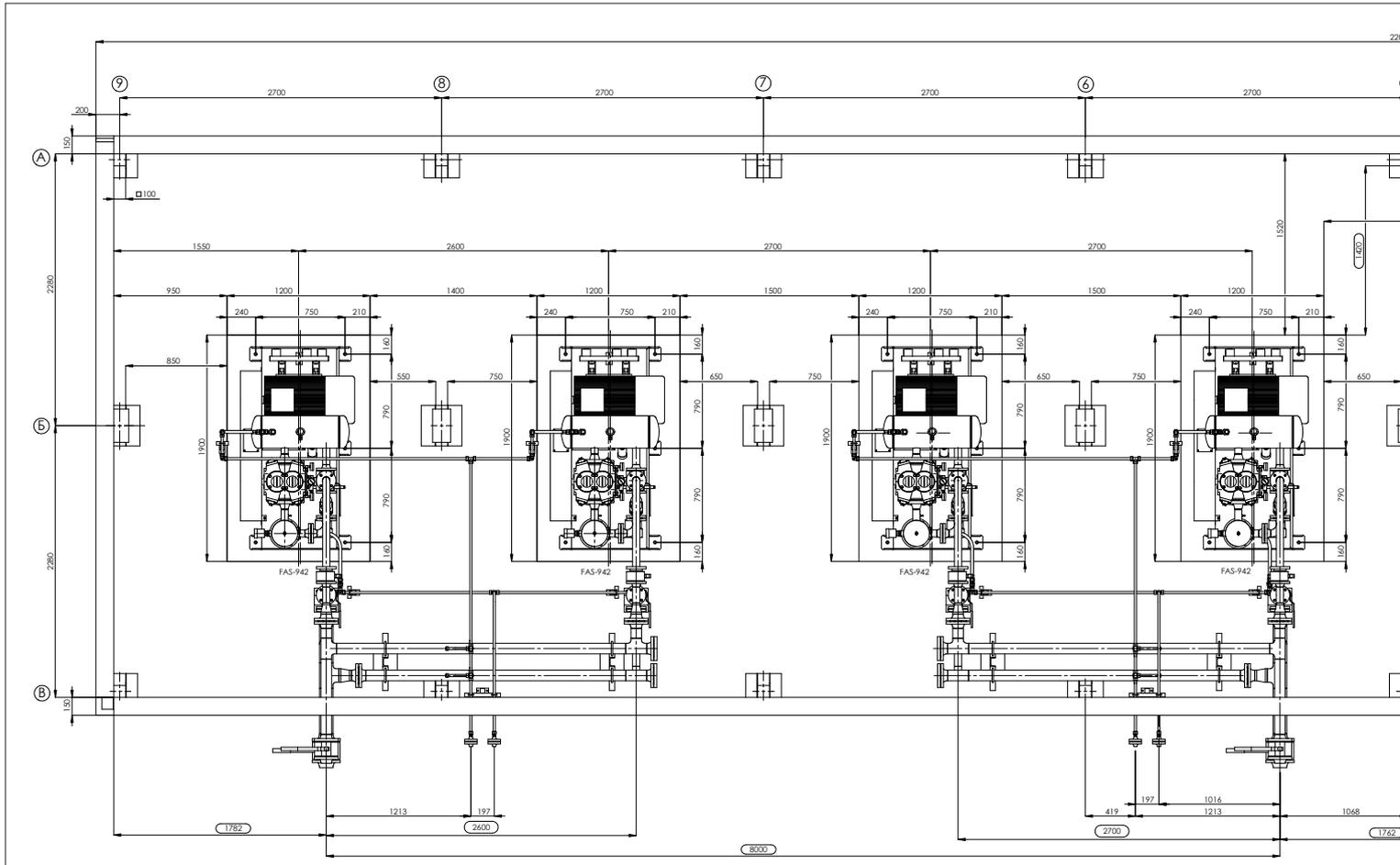

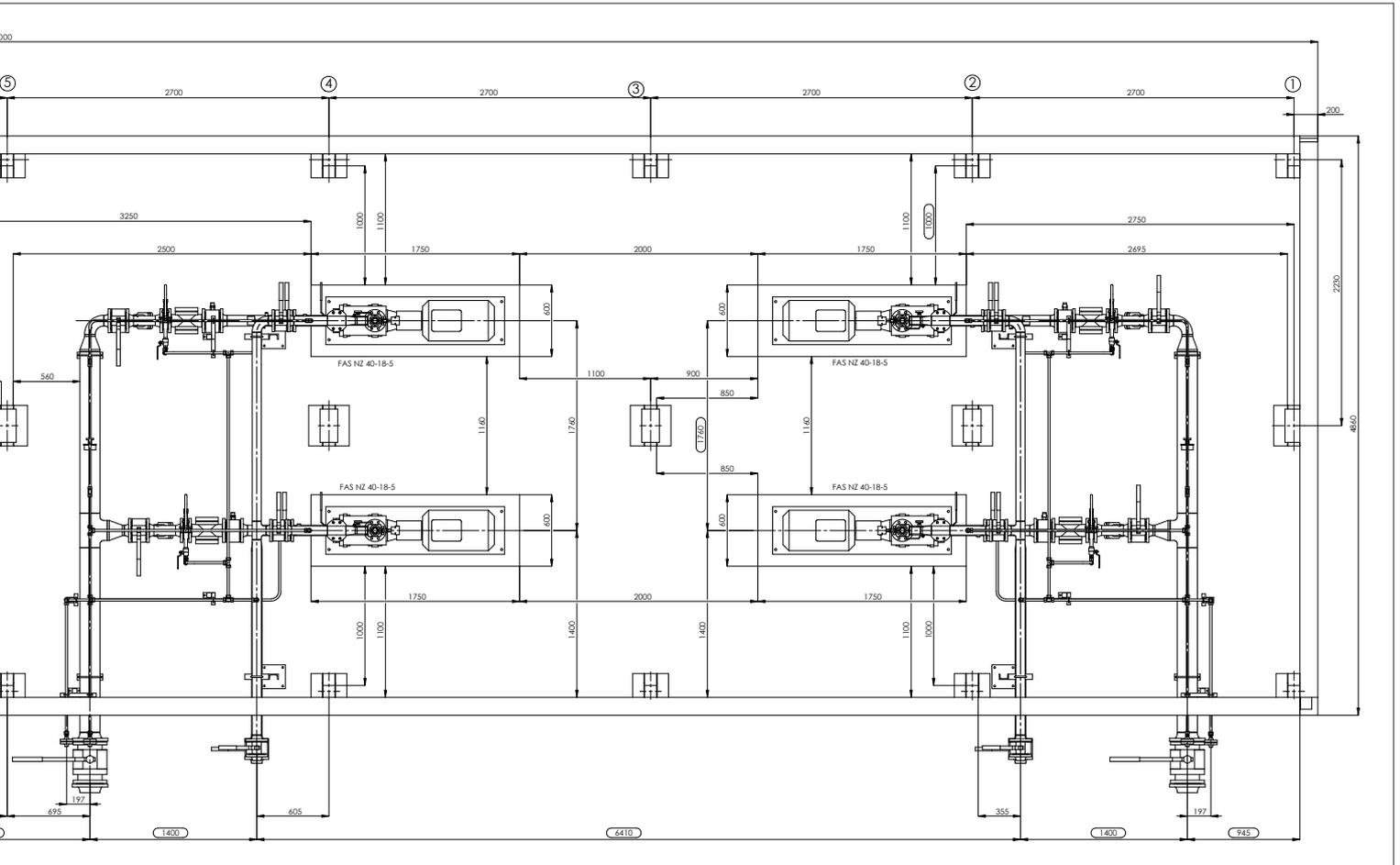

# A Accessories, additional equipment and safety devices for piston compressors

## Mechanical liquid trap type FAS

- made from steel
- with ball valve 3/8" NPT made from steel for condensate drainage
- available connection for installation of an electrical filling-level sensor



## Mechanic liquid trap Type FAS

- made from steel

FAS No.	Type Compressor	Connection	Content, l	Weight, kg
21 171	Blackmer 161/162/361/362	1 1/4"	9,7	14,4
21 170	Corken 290/291/D291/490/491/D491		9,7	14,4
21 172	Blackmer 601/602		13,0	16,3

## Pneumatic actuator for 4-way ball valve

- without spring reset
- operating angle 90°
- designed to handle a pilot pressure of 5-8 bar
- complete with mounting bracket and screws



with NPT-thread



with DIN-flanges

FAS No.	Type compressor	Connection	Execution	Content, l	Weight, kg
21 130	161/162	DN 20	TKW for stationary systems	5,8	18,4
21 131	161/162	DN 25		5,8	18,7
21 132	361/362	DN 32		5,8	19,1
21 133	601/602	DN 40		7,8	21,3
21 134	942	DN 50		30,0	49,4
26 130	Filling-level sensor type VEGASWING, probe – stainless steel L=69 mm, case: synthetic, operating temperature range 40...150°C, operating pressure – up to 64 bar				
26 301	Switch amplifier for stationary systems, 1 channel intrinsically safe circuit (Ex i) IIC with relay outlet, 1 changeover contact, supply voltage: 230 V, 45...65 Hz, NAMUR				
21 137	Shut-off device, pneumatic, PN25 (for trucks), connection 2" NPT AG, control pressure 1,4 – 4,1 bar				

FAS No.	Execution
21 180	with NPT female thread (FAS No. 21140-21143)
21 020	with DIN flanges DN 20-32 (FAS No. 21147-21149)
21 181	with DIN flanges DN 40-50 (FAS No. 21150 and 21144)
21 200	Limit switch in housing, Ex-proof, for position feedbacks, without display
19 748	5/2-way solenoid valve, Ex-proof, with NAMUR connection, for compressed air max. 10 bar, thread connection G1/4", operating voltage 230 V-AC, 50 Hz
19 749	5/2-way solenoid valve, Ex-proof, with NAMUR connection, for compressed air max. 10 bar, thread connection G1/4", operating voltage 24 V-DC

## Safety relief valve PN 40 for stationary systems

- angled form, soft seal
- free of non-ferrous metal
- set at 19 bar

FAS No.	Inlet/outlet, "	Weight, kg
21 145	G3/4 AG / G1/2 IG	2,3



**4-way ball valve PN 40**

- from forged steel
- acc. to AD A4 requirements
- seals from PTFE/Viton

**Executions:**

- A – with manual lever
- B – with pneumatic actuator without spring reset, operating angle 90°, designed to handle a pilot pressure of 5-8 bar



FAS No.	Execution	Weight, kg	Connection	Type Compressor
21 140	A	5,1	¾" NPT	161/162
21 141	A	7,3	1" NPT	161/162
21 142	A	7,3	1¼" NPT	361/362
21 143	A	7,4	1½" NPT	601/602
21 240	B	16,3	¾" NPT	161/162
21 241	B	18,5	1" NPT	161/162
21 242	B	18,5	1¼" NPT	361/362
21 243	B	18,6	1½" NPT	601/602
21 147	A	5,7	DN 20	161/162

FAS No.	Execution	Weight, kg	Connection	Type Compressor
21 148	A	7,1	DN 25	161/162
21 149	A	12,5	DN 32	361/362
21 150	A	14,2	DN 40	601/602
21 144	A	16,1	DN 50	942
21 247	B	16,9	DN 20	161/162
21 248	B	18,3	DN 25	161/162
21 249	B	23,7	DN 32	361/362
21 250	B	25,4	DN 40	601/602
21 244	B	27,3	DN 50	942

**Flexible hose PN40**

- from stainless steel
- on both sides lapped flanges acc. to DIN2656 from C-steel
- welded execution
- with single stainless steel covering
- for flexible connection of compressors to the pipeline



FAS No.	Nominal diameter, DN	Length, mm	Weight, kg
21 175	25	1000	4,0
21 191	32		5,0
21 192	40		6,3
21 193	50		7,6
82 739	80		14,5

## Temperature monitoring at the compressor outlet



Art. 26 312

FAS No.	Description
26 1356	Filling-level sensor, M20 screw connection, PN40, output – 2-wire NAMUR-signal, designed for use in Ex zone
26 3020	Isolating amplifier for switch box installation, 2 channels, intrinsically safe circuit EEx ia IIC, 2 relay outlets, supply voltage: 24-230 V, 50 Hz
26 312	Resistance thermometer PT 100, M18x1,5 AG connection, stainless steel probe Ø 6 mm, length 100 mm, 3-wire-connection, for temperature monitoring of compressed gas
26 3144	Process transmitter with control unit RMA42 for resistance thermometer PT 100, intrinsically safe loop power supply, with universal inputs and analogue outputs. Operating voltage: 24-230 V AC/DC.
26 316	Welding Thermometer well for temperature sensor acc. to DIN 43769. Form D1, material C 22.8

## Pressure monitoring for compressor suction and pressure line

FAS No.	Description
<b>High pressure switch (pressure side), setting range 4-25 bar, set at 15 bar</b>	
EU 18 4561 non EU 18 456	Pressure switch with Ex I – equipment, for intrinsically safe circuits, break contact with resistance combination for break of circuit and short circuit monitoring, single pole changing over, gilt contacts, differential gap 1,0 bar, only for suitable switch amplifiers (FAS 26301 against more cost).
<b>Low pressure switch (suction side), setting range 0,5-6,0 bar, set at 0,8 bar</b>	
EU 18 4573 non EU 18 457	Pressure switch with Ex i – equipment, for intrinsically safe circuits, break contact with resistance combination for break of circuit and short circuit monitoring, single pole changing over, pressure side connection – nipple G1/2"-AG, gilt contacts, differential gap 0,25 bar, only for suitable switch amplifiers (26301 against more cost).
<b>Pressure switch oil-pressure control, setting range 0,5-6,0 bar, set at 1 bar</b>	
EU 18 4621 non EU 18 462	Pressure switch with EX I – equipment, for intrinsically safe circuits, break contact with resistance combination for break of circuit and short circuit monitoring, single pole changing over, gilt contacts, differential gap 0,2 bar, only for suitable switch amplifiers (FAS 26301 against more cost).
<b>Accessories for pressure switches</b>	
21 195	Bracketry for securing pressure switch to steel base plate including pulse conductors and assembly



## B

## Pumps

**LPG-Pumps**

for LPG filling stations, trucks and stationary facilities

- housing from ductile cast iron ASTM A536
- mechanical seal
- with free shaft end

**Executions:**

- A – with NPT thread flanges
- B – with flanges acc. to DIN 2635
- C – with ANSI-flanges for internal valve

FAS No.	Execution	Pump Type	Capacity, l/min (capacity data at 5 bar differential pressure)	Max. differential pressure, bar	Weight, kg
---------	-----------	-----------	--	------------------------------------	------------

**Corken-Pumps**

EU 21 608	B	FD150	180	13,5	28,0
non EU 21 7088					
21 296	A	Z2000	309	8,6	39,0
21 297	C	Z3200	424	8,6	71,0
91 727	C	Z3500	500	8,6	76,0
21 788	C	Z4200	1390	8,6	96,0
21 718	C	Z4500	1390	8,6	92,0

**Blackmer-Pumps**

21 301	A	LGB 1" C	20	8,6	9,0
21 302	A	LGB 1" PC	35	8,6	9,0
21 303	A	LGL 1¼"	50	10,5	14,0
21 304	A	LGL 1½"	90	10,5	14,0
21 305	A	LGL 2" E	220	10,5	40,0
21 306	A	LGL 3" E	490	10,5	74,0
21 337	B	LGL 4"	950	10,5	99,0

**BLACKMER pumps for road tankers**

FAS No.	Pump	Remarks
21 331	LGLD3 F (NPT)	Complete with 3" NPT threaded flanges, shaft exit on both sides
21 332	LGLD3 F (SA)	Complete with 3" welding flanges, shaft exit in both directions
21 300	LGL3 F (OFL)	Flanges excluded, right hand rotation
21 334	LGLD4 F (SA)	Complete with welding flanges 4" (inlet) 3" (outlet), shaft exit on both sides
21 327	TLGLF4B (SA)	Inlet 4" ASME, outlet 3" and 2 pcs of 2" welding flanges, right hand rotation

**Pump unit type FAS-Corken FD-150**

- housing from ductile cast iron ASTM A536
- flow rate – up to 180 l/min
- max. differential pressure – 13,5 bar
- speed – up to 3000 U/min
- inlet – flange DN 40 (PN 40, DIN 2635)
- outlet – flange DN 25 (PN 40, DIN 2635)
- dimensions – 800×385×260 mm
- mechanical seal
- coupling
- Ex-Motor 400/690 V/50 Hz AC, E Ex II T3
- coupling protection
- mounted on a base plate, primed and painted



FAS No.	Motor capacity, kW
EU 91 434	4,6
EU 91 501	5,5
non EU 91 5025	5,5

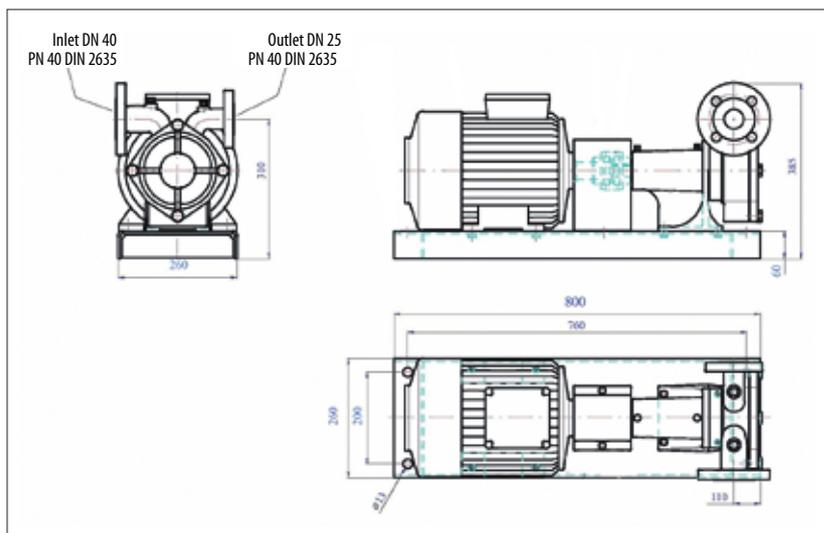

*Dimensional drawing  
of the pump unit FAS-Corken FD-150*

### Pump unit FAS-Corken or FAS-Blackmer

- for positive suction head
- pump case of ductile iron ASTM A536
- with single-acting mechanical seal
- complete unit mounted on a common base plate from steel
- ready for connection, primed and painted
- with Ex-spur-gear-motor 400/690 V, 50 Hz, including coupling and coupling protection

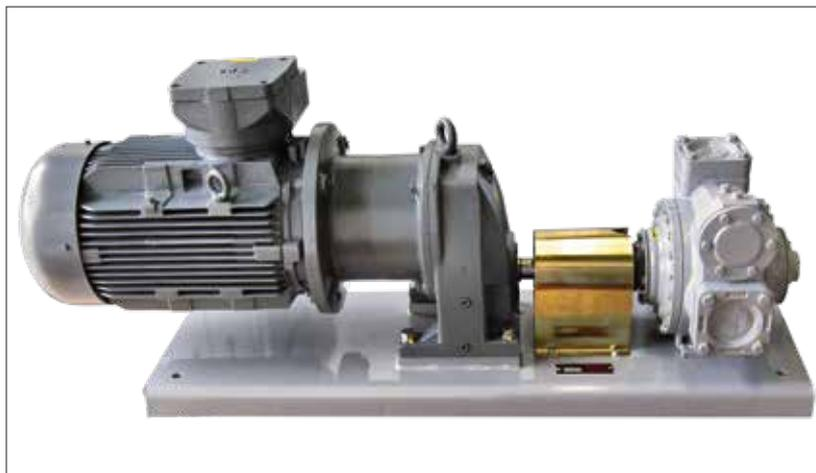

FAS No.	Pump Type	Motor, kW	Capacity, l/min	Speed, RPM	Weight, kg
21 225	FAS-Corken Z 2000	5,0	190 (power rating at 7 bar differential pressure)	560	120
21 3160	FAS-Corken Z 3500	10,0	480 (power rating at 7 bar differential pressure)	560	243
21 808	FAS-Corken Z 4500	15,0	950 (power rating at 5 bar differential pressure)	560	413

*The pump units can be equipped with other motors of different capacities or speed as well in various types of protection (for example flameproof / Ex d)*

21 311*	FAS-Blackmer LGL 1"E	1,0	18	1500	32,0
21 312*	FAS-Blackmer LGL 1"PE	1,0	34	1500	32,0
21 313	FAS-Blackmer LGL 1,25"E	2,0	60	1500	56,0
21 314	FAS-Blackmer LGL 1,5"E	2,0	94	1500	61,0
21 354**	FAS-Blackmer LGL 1,5"E	3,6	94	1500	64,0
21 315	FAS-Blackmer LGL 2"E	5,0	220	560	130,0
21 316	FAS-Blackmer LGL 3"E	10,0	400	580	230,0
21 317	FAS-Blackmer LGL 4"E	15,0	800	580	420,0

\* These pumps are equipped with an internal by pass valve (for interrupted cut operation) with connection to the return line in the tank, during continuous rating an external by pass valve must be used additionally

\*\* This pump unit with a higher motor capacity can reach a max. differential pressure of approx. 10 bar at smaller delivery rate

**Pump unit Type FAS-Corken**

- for positive suction head
- pump case of ductile iron ASTM A536
- with single-acting mechanical seal
- complete unit mounted on a common base plate from steel
- ready for connection, primed and painted
- with Ex-V-belt-motor 400/690 V, 50 Hz, speed – 610 RPM, class of protection – Ex II 2 G Ex e II T3 Gb, including V-belt drive and V-belt pulley



FAS No.	Pump Type	Motor, kW	Capacity, l/min	Weight, kg
21 2251	Z 2000	5,5	270	143,0
21 8089	Z 3500	11,0	490	266,0
21 8088	Z 4500	15,0	950	332,0

FAS No.	Pump Type	Motor, kW	Capacity, l/min	Weight, kg
21 3700	BLACKMER LGL2	5,5	270	143,0
21 3810	BLACKMER LGL3	11,0	490	266,0
21 3900	BLACKMER LGL4	15,0	950	332,0



FAS-Corken  
pump unit Z 3500

**Pump unit with hydraulic motor**

- for positive suction head
- pump case of ductile iron ASTM A536
- with single-acting mechanical seal
- complete unit consisting of pump hydraulic adaptor, coupling and hydraulic motor
- ready for connection mounted, primed and painted

FAS No.	Pump Type	Motor, kW	Capacity, l/min	Speed, RPM	Oil recirculated quantity, l/min	Oil pressure, bar
<b>Pump with NPT-threaded flanges, right-handed, execution A (Corken/Danfoss)</b>						
21 5720	FAS-Corken Z 2000/OM 80	5,5	220	640	58,0	100
21 299	FAS-Corken Z 3200/OM 100	10,0	450	550	29,0	232
21 2995	FAS-Corken Z 3200/OM 80	8,0	400	750	52,0	110
21 2998	FAS-Corken Z 3500/OM 80	10,0	450	550	60,0	140
21 2994*	FAS-Corken Z 3500/OM 80	8,0	450	550	60,0	110

\*left-handed. Other pump units left-handed on your request. Power rating at 5 bar differential pressure. Inlet flange 3" ANSI 300 lbs

FAS No.	Pump Type	Motor, kW	Capacity, l/min	Speed, RPM	Oil recirculated quantity, l/min	Oil pressure, bar
<b>Pump with welding ends, right-handed, execution A (Blackmere/Danfoss)</b>						
21 572	FAS-Blackmer LGL 2"/E/OM 80	5,0	220	650	58,0	100
21 573	FAS-Blackmer LGL 3"/OM 100	10,0	380	550	29,0	232
21 574	FAS-Blackmer LGL 3"/OM 100	10,0	380	550	60,0	140
21 576	FAS-Blackmer LGL 2"/E/OM 80	5,0	220	650	58,0	100
21 577	FAS-Blackmer LGL 3"/OM 100	10,0	380	550	29,0	232
21 578	FAS-Blackmer LGL 3"/OM 100	10,0	380	550	60,0	140

Pump units left-handed on your request. Power rating at 5 bar differential pressure.

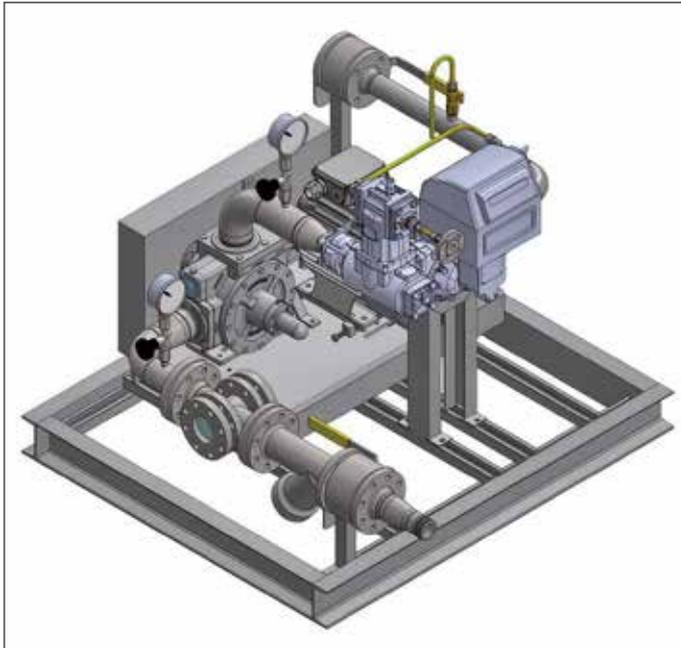

### Complete pump and meter units based on CORKEN/BLACKMER pumps

- serial production
- assembled on a single frame and is completely ready for operation

FAS No.	Pump type	Meter, type	Capacity, l/min	Motor, kWt
93 1886	Z 2000	MA 7, PD Meter	250	5,0
93 1881	Z 3500	MA 7, PD Meter	400	10,0
93 1883	Z 4500	MA 15, PD Meter	900	15,0
93 1887	Z 2000	MID 400, coriolis meter	250	5,0
93 1888	Z 3500	MID 400, coriolis meter	400	10,0
93 1889	Z 4500	MID 800, coriolis meter	900	15,0
93 1890	Z 2000	without meter	250	5,0
93 1891	Z 3500	without meter	400	10,0
93 1892	Z 4500	without meter	900	15,0

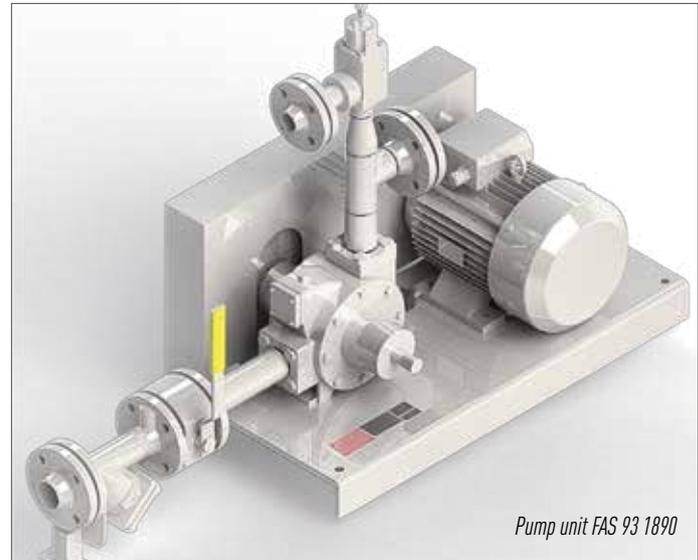
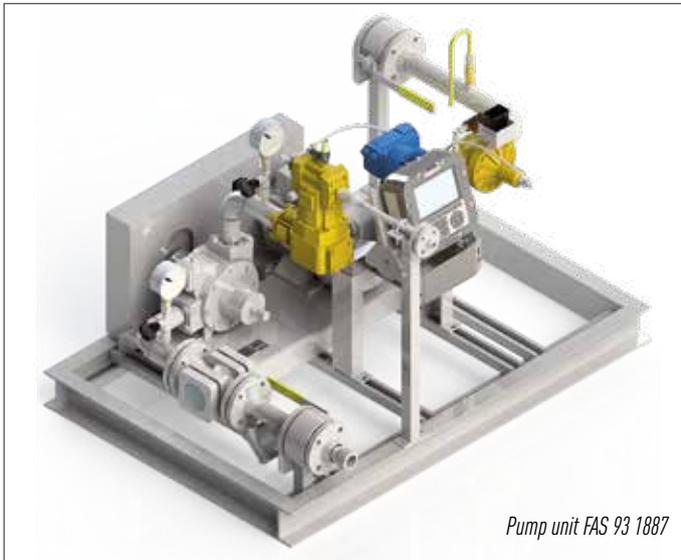

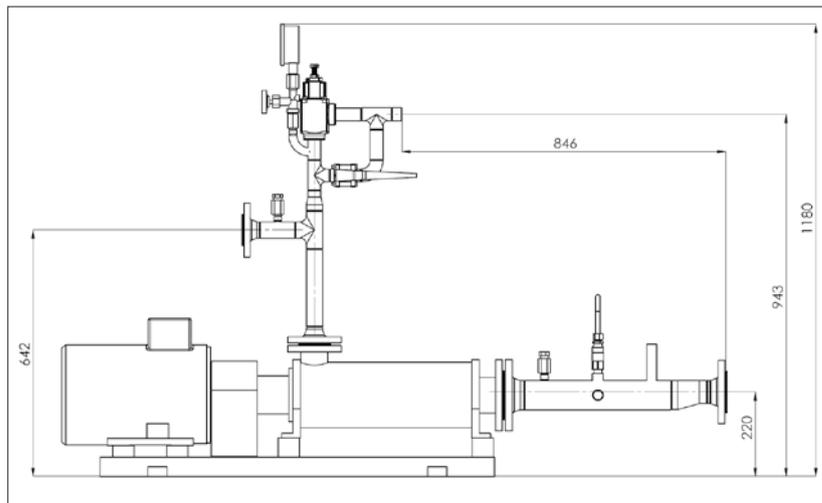
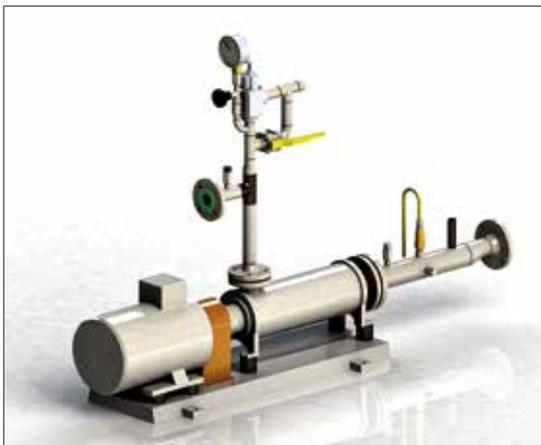

### Complete „ready to use“ pump unit for refueling of cars

- side channel pump
- coupling with coupling protection
- Ex-motor 400/690 V/50 Hz AC, E Ex II T3
- gas bubble trap
- mounted on a ground frame, grounded and painted

FAS No.	Pump unit/ motor capacity, kW	Connection DIN (Inlet/Outlet)	Max. differential pressure, bar	Capacity, l/min (at differential pressure 10 bar)
93 3113	NZ 36-6/5	50/32	10	50
93 3112	NZ 36-8/5	50/32	14	100

### Additional equipment

FAS No.	Description	Connection
92 156	Ball valve	DIN 50
18 5930	Sight flow indicator	DIN 50
14 0168	Strainer	DIN 50
12 534	Back check valve	DIN 50
18 382	Flow detector dip sensor	½" NPT
18 381	Flow detector analyzing device	230 V AC

### Complete suction pump unit for the transfer of LPG from underground tanks

- side channel pump
- coupling with coupling protection
- Ex-motor 400/690 V/50 Hz AC, E Ex II T3
- gas bubble trap
- mounted on a ground frame, grounded and painted

The complete side channel pump unit is equipped with two types of pump units:

- capacity 50 l/min (for one or two dispensers);
- capacity 100 l/min (for two or three dispensers),
- with three phase motor 5 or 6,8 kW.

The gas bubble trap facility is equipped with a mechanical liquid gas trap, by-pass valve, pressure gauge with shut-off valve, back check valve, ball valve and differential valve, strainer and pipe line.

#### Executions:

- A – with 3-phase motor 5 or 6,8 kW, with sight flow indicator
- B – with 3-phase motor 5 or 6,8 kW, without sight flow indicator

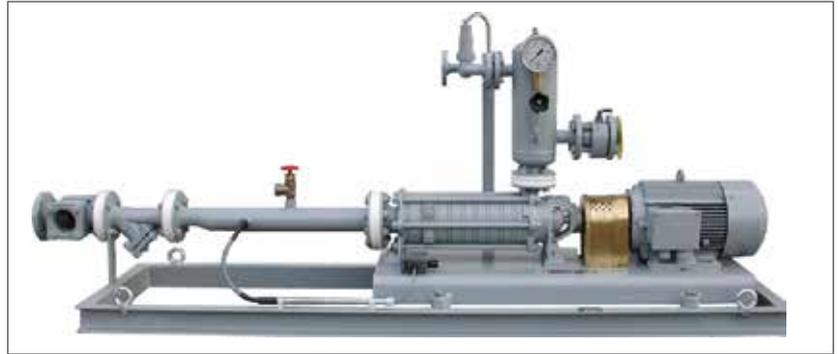

FAS No.		Pump unit type	Connection DN (Inlet/Outlet)	Max. differential pressure, bar	Capacity l/min at differential pressure 10 bar	Weight, kg	
Execution A	Execution B					Execution A	Execution B
21 707	21 776	AP 31-8	50/32	14	50	300,0	220,0
21 708	21 777	AP 36-8	50/32	14	100	320,0	240,0

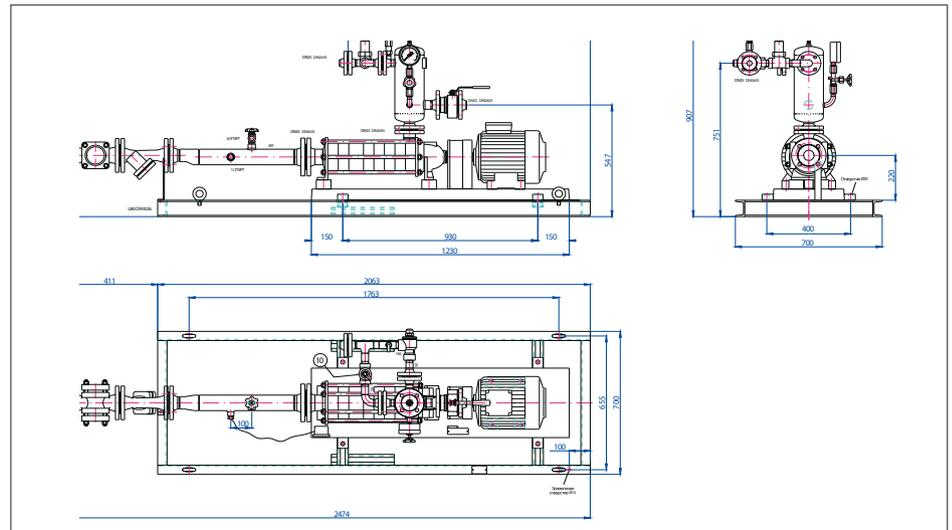

Dimensional drawing of complete suction pump unit capacity 50/100 l/min with 3-phase motors 5/6,8 kW

### LPG side channel pump unit for above ground and underground tanks

- for positive suction heads
- mechanical seal
- flanges in PN 25/40 with flat seal strip
- Ex 3-phase motor 400/690 V/50 Hz AC, E Ex II T3
- coupling with coupling protection
- mounted on a ground frame, grounded and painted

#### Executions:

- A – side channel pump unit for above ground tanks; with mechanical seal, coupling and coupling protection
- B – side channel pump unit for underground tanks; with mechanical seal, coupling and coupling protection

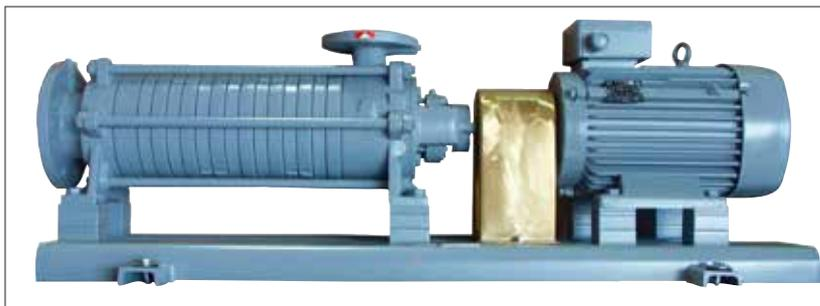

*Horizontal, self-priming pump unit in a link-body version with open impellers*

FAS No.	Execution	Type	Max. differential pressure, bar	Motor capacity, kW	Connection, DN		Capacity, l/min
					Inlet	Outlet	
21 720	A	FAS NZ 12-5	6	1,0	40	20	10
21 783	A	FAS NZ 31-6	10	3,6	65	32	50
21 781	A	FAS NZ 31-7	14	3,6	65	32	50
21 784	A	FAS NZ 36-6	10	5,0	65	32	100
21 729	A	FAS NZ 36-8	14	5,0	65	32	100
21 807	A	FAS NZ 51-6	14	13,5	100	50	200
21 787	A	FAS NZ 51-8	14	15,0	100	50	300
21 795	A	FAS NZ 61-8	14	24,0	100	65	500
21 785	B	FAS AP 31-8	14	5,0	65	32	50
21 786	B	FAS AP 36-8	14	6,8	65	32	100





#### Executions:

- A – bare shaft pump
- B – pump including coupling, coupling protection and base plate (without motor)
- C – pump including coupling, coupling protection, base plate and Ex e motor

Type	FAS No.			Capacity, m <sup>3</sup> /h	Differential pressure, bar	Motor capacity, kW
	Execution					
	A	B	C			
FAS-NZ 40-6 (NHE 603 E162L)	46 0713	46 081	46 001	40 (by 6 bar)	7,0	12,5
FAS-NZ 40-8 (NHE 604 E162L)	46 072	46 082	46 002	40 (by 8 bar)	9,0	15,0
FAS-NZ 40-10 (NHKE 605 E162L)	46 073	46 083	46 003	40 (by 10 bar)	11,5	20,0
FAS-NZ 60-5 (NHE 1003 E160L)	46 074	46 084	46 004	60 (by 5 bar)	5,6	15,0
FAS-NZ 60-7 (NHE 1004 E160L)	46 075	46 085	46 005	60 (by 7 bar)	7,7	20,0
FAS-NZ 60-10 (NHKE 1006 E160L)	46 076	46 086	46 006	60 (by 11 bar)	12,0	28,0
FAS-NZ 80-6 (NHKE 1003 G170)	46 077	46 087	46 007	80 (by 6 bar)	6,0	24,0
FAS-NZ 80-7 (NHKE 1004 G170)	46 078	46 088	46 008	80 (by 7,5 bar)	8,5	24,0
FAS-NZ 80-11 (NHKE 1005 G170)	46 079	46 089	46 009	80 (by 11 bar)	13,0	47,0
FAS-NZ 100-5 (NHKE 1003 G170)	46 0710	46 0810	46 010	100 (by 5 bar)	6,0	24,0
FAS-NZ 100-7 (NHKE 1004 G170)	46 0711	46 0811	46 011	100 (by 7 bar)	8,0	28,0
FAS-NZ 100-10 (NHKE 1005 G180)	46 0712	46 0812	46 012	100 (by 11,5 bar)	11,5	47,0
FAS-NZ 150-7 (NHKE 1003 G180)	46 0714	46 0813	46 013	150 (by 7 bar)	7,0	36,0
FAS-NZ 150-10 (NHKE 1006 G180)	46 0715	46 0815	46 015	150 (by 12,5 bar)	12,5	58,0

Privileged pump group for cylinder carousels (filling of cylinders) and road tanker refueling (execution A)

FAS No.	Type	Capacity, m <sup>3</sup> /h (l/min)	Differential pressure, bar	Motor capacity, kW	Connection, DN (Inlet/Outlet)
46 0204	NZ 30-9-15	30 (500)	9	15	80/65
46 0203	NZ 30-9			pump only	
46 0206	NZ 25-13-15	25 (400)	13	15	80/65
46 0209	NZ 25-13			pump only	
46 0207	NZ 30-14-24	30 (500)	14	24	80/65
46 0208	NZ 30-14			pump only	

**Complete pump unit for the transfer of LPG**

- side channel pump
- coupling with coupling protection
- Ex-motor 400/690 V/50 Hz AC, E Ex II T3
- gas bubble trap
- mounted on a ground frame, grounded and painted

FAS No.	Pump unit	Inlet/Outlet/by pass line	Max. differential pressure, bar	Capacity l/min at differential pressure 10 bar	Weight, kg
93 2487	NZ 28-10-15	DN 80/65/40	11,3	500	860
93 3098	NZ 40-8-15	DN 80/65/40	9,5	660	775

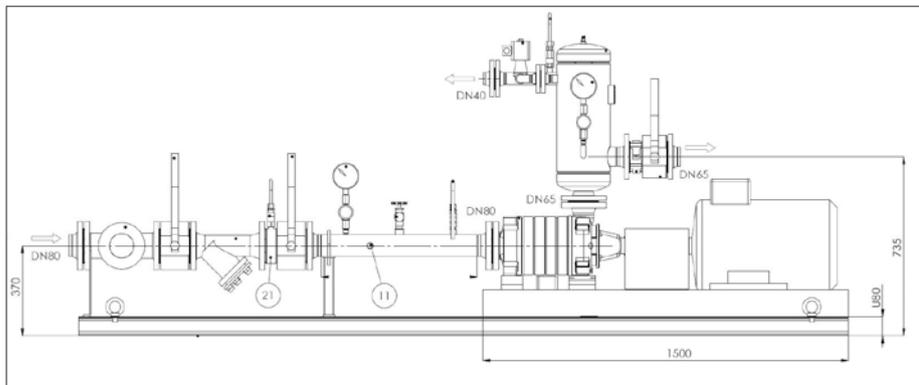

Dimensional drawing of complete suction pump unit 93 2487

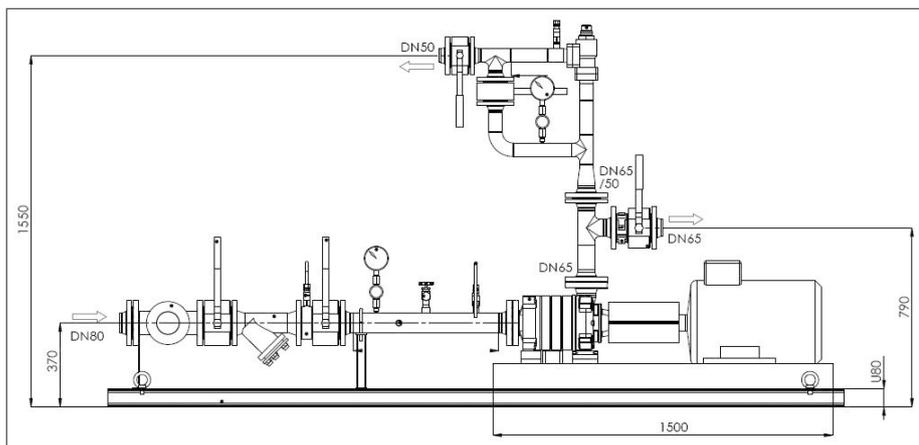
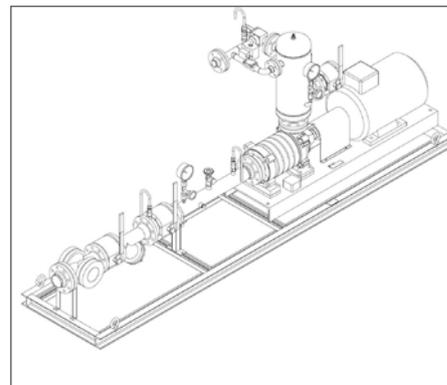

Dimensional drawing of complete suction pump unit 93 3098

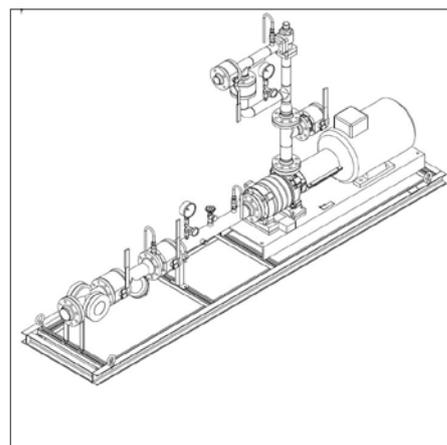



### Turbine pumps EBSRAY

- working pressure – up to 25 bar
- pump case material – ASTM A395
- mechanical seals

FAS No.	Pump type	Capacity (max), l/min	Weight, kg
91 260	RC 20	50	19.5
91 770	RC 25	90	19.5
91 782	RC 40	165	37.5



### Pump units EBSRAY

- motor 400/690 V (Ex e II 2G T3)
- coupling with protective sleeve
- common steel painted frame
- factory assembly
- full test cycle
- ready for use

Type A consists of:

- pump
- directly coupled motor
- base plate
- by pass valve

Type B consists of:

- pump
- directly coupled motor



FAS No.	Pump type	Bypass valve type	Motor, kWt	Type	Weight, kg
21 7547	RC 20	RV18-VRS10	2,5	A	70
21 754	RC 25		2,5	A	70
21 7569	RC 40	RV18-VRS14	5,5	A	110
21 7558	RC 20	-	3,0	B	-
21 7559	RC 25	-	3,0	B	-
21 7562	RC 40	-	5,5	B	-

Original couplings for RC pumps

Pump type	FAS No.	Motor shaft $\varnothing$ , mm
RC 20/25	91 771	24
	91 772	28
RC 40	91 7720	28
	91 7721	38



## Dispensers LPG • Refueling stations LPG

### FAS 35 4736 electronic LPG dispenser type FAS-120

Operation pressure, bar	up to 25
Flow capacity, l/min	
min.	5
max.	50
Weight, kg	110
Dimensions, mm:	
Height (entire dispenser)	1500
Height (mechanical part)	1000
Width	500
Depth	400
Power supply	230 V AC, 50 Hz

Counter-Display (kg)/LCD-Display	1 (inside)/1
Hydraulic	PN 25
Coriolis flow meter	5-50 l/min

Equipment: vapor eliminator with fine mesh filter, differential pressure valve, back check pressure valve, safety relief valves, expansion vessel, high pressure hose LPG 19 (length 5 m) with excess flow valve and breakaway coupling

Connection: liquid phase / gas return line	Ball valve 3/4 G IG / Ball valve 3/4 G IG
--	--

Information data at LCD-Display "price per liter", "filling volume liter", "total sum"

Protocols: Easy Call, DART, Pumalan, Nara

Information data at internal counter-display: volume, kg, density and temperature data of LPG

#### Additional equipment (against extra cost):

solenoid valve (single- or double-acting), heating for electronic part, insulating flange set for underground pipe lines

34 9331	Remote control "SERVICE" for programming
34 9330	Remote control "USER"
22 117	Heating dispenser electronics
22 7591	Preset equipment
34 0860	Automatic hose return
22 1175	LPG hose DN19



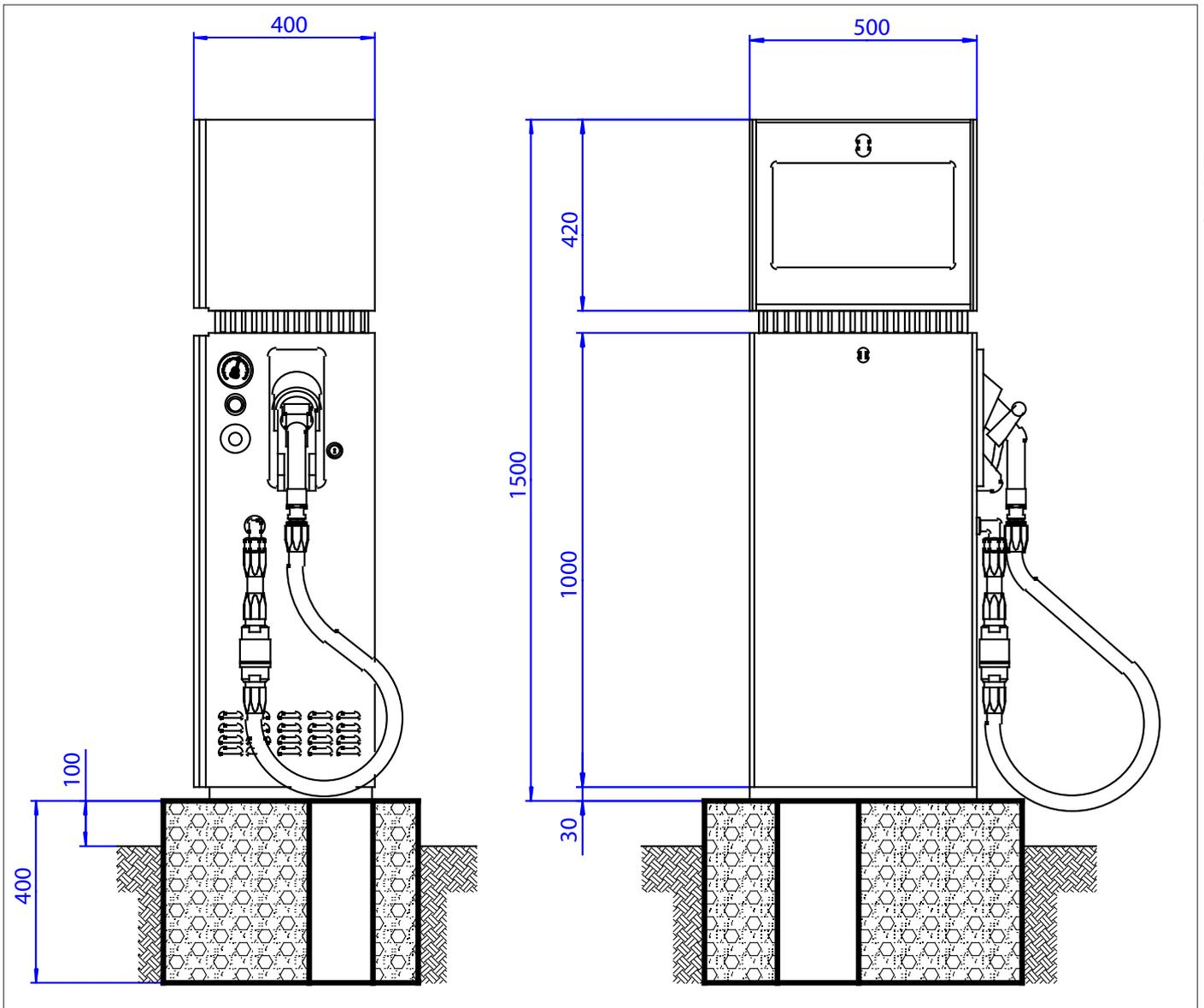

Dimensional drawing of LPG-dispenser type FAS-120

**FAS 35 4737 electronic LPG dispenser type FAS-220 (one hose)****FAS 35 4738 electronic LPG-dispenser type FAS-230 (two hoses)**

Operation pressure, bar	up to 25
Flow capacity, l/min	
min.	5
max.	50
Weight FAS-220/FAS-230, kg	190/220
Dimensions, mm:	
Height (entire dispenser)	2109
Width	1200
Depth	520
Power supply	230 V AC, 50 Hz
Housing execution	High Mast (HM), from stainless steel

Dispensers FAS-230 differ from dispensers FAS-220 in their construction in so far that all components required for delivery of product are doubled.

Counter-Display (kg/)	1 (inside)/1 (FAS-220)
LCD-Display	2 (inside)/2 (FAS-230)
Hydraulic	PN 25
Coriolis flow meter (0...50 l/min)	1 (FAS-220)/1 (FAS-220)

Equipment: vapor eliminator with fine mesh filter, differential pressure valve, back check pressure valve, safety relief valves, expansion vessel, high pressure hose LPG 19 (length 5 m) with excess flow valve and breakaway coupling

Connection: liquid phase / gas      Ball valve 3/4" G IG /  
return line                              Ball valve 3/4" G IG

Information data at LCD-display "price per liter", "filling volume liter", "total sum"

Information data at internal counter-display: volume, kg, density and temperature data of LPG

Protocols: Easy Call, DART, Pumalan, Nara

**Additional equipment (against extra cost):**

solenoid valve (single- or double-acting), heating for electronic part, insulating flange set for underground pipe lines

<b>34 9331</b>	Remote control "SERVICE" for programming
<b>34 9330</b>	Remote control "USER"
<b>22 117</b>	Heating dispenser electronics
<b>22 7591</b>	Preset equipment
<b>34 0860</b>	Automatic hose return
<b>22 1175</b>	LPG hose DN19



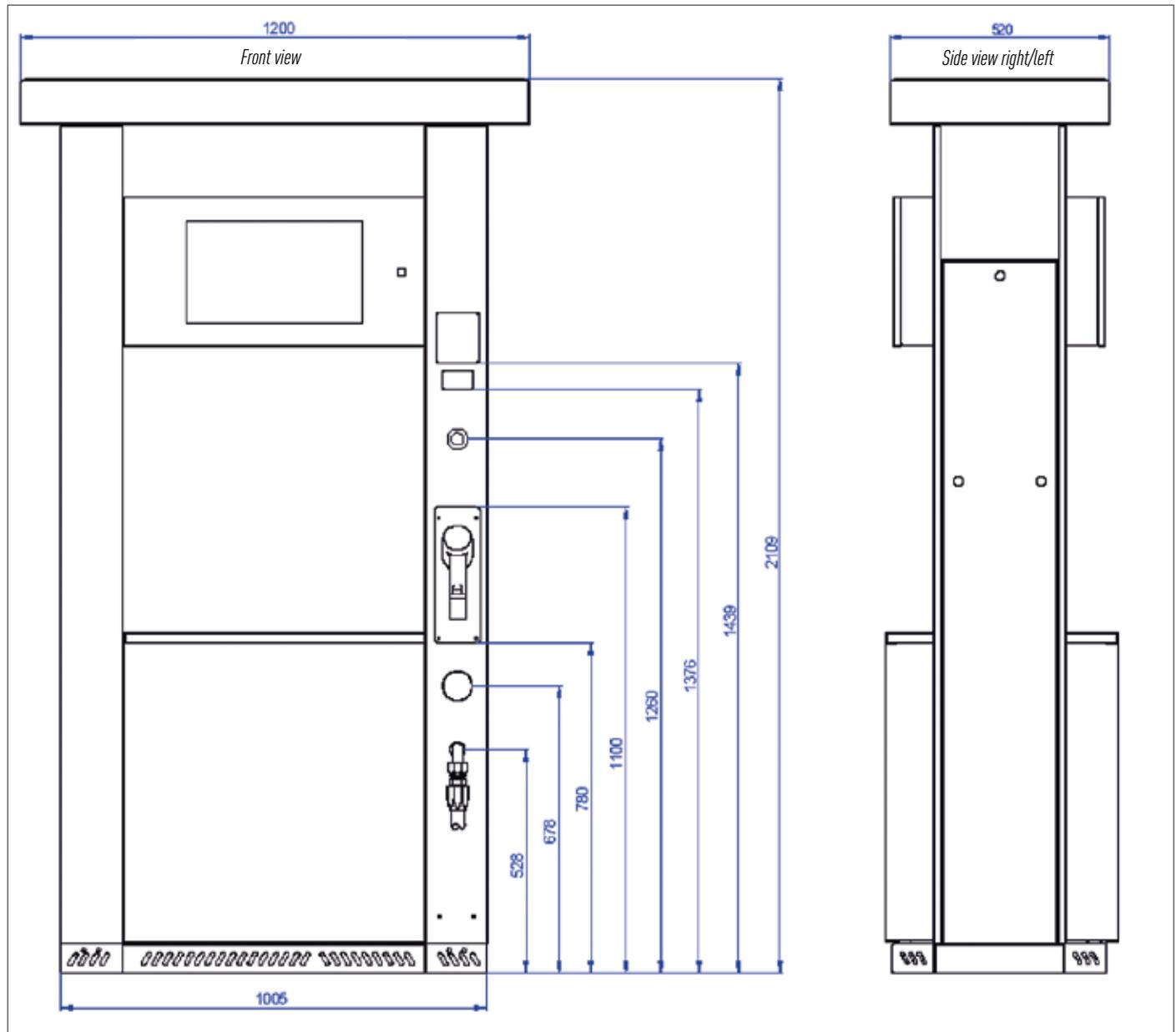

Dimensional drawing of electronic LPG-dispenser  
Type FAS-220/FAS-230

### FAS 35 4763 electronic LPG-dispenser type FAS-230 (two hoses)

Operation pressure, bar	до 25
Flow capacity, l/min	
min	5
max	50
Weight, kg	210
Dimensions, mm:	
Height (dispenser)	1805
Height (mechanical)	718
Width	1011
Depth	505
Power supply	230 V AC, 50 Hz
Housing execution	HM-E, stainless steel

Counter-Display (kg)/ LCD-Display	2 (inside)/2
Hydraulic	PN 25
Coriolis flow meter (0...50 l/min)	1

Equipment: vapor eliminator with fine mesh filter, differential pressure valve, back check pressure valve, safety relief valves, expansion vessel, high pressure hose LPG 19 (length 5 m) with excess flow valve and breakaway coupling

Connection: liquid phase / gas return line	Ball valve 3/4" G IG
---	----------------------

Information data at LCD-display "price per liter", "filling volume liter", "total sum"

Information data at internal counter-display: volume, kg, density and temperature data of LPG

Protocols: Easy Call, DART, Pumalan, Nara

#### Additional equipment (against extra cost):

solenoid valve (single- or double-acting), heating for electronic part, insulating flange set for underground pipe lines

34 9331	Remote control "SERVICE" for programming
34 9330	Remote control "USER"
22 117	Heating dispenser electronics
22 7591	Preset equipment
34 0860	Automatic hose return
22 1175	LPG hose DN19





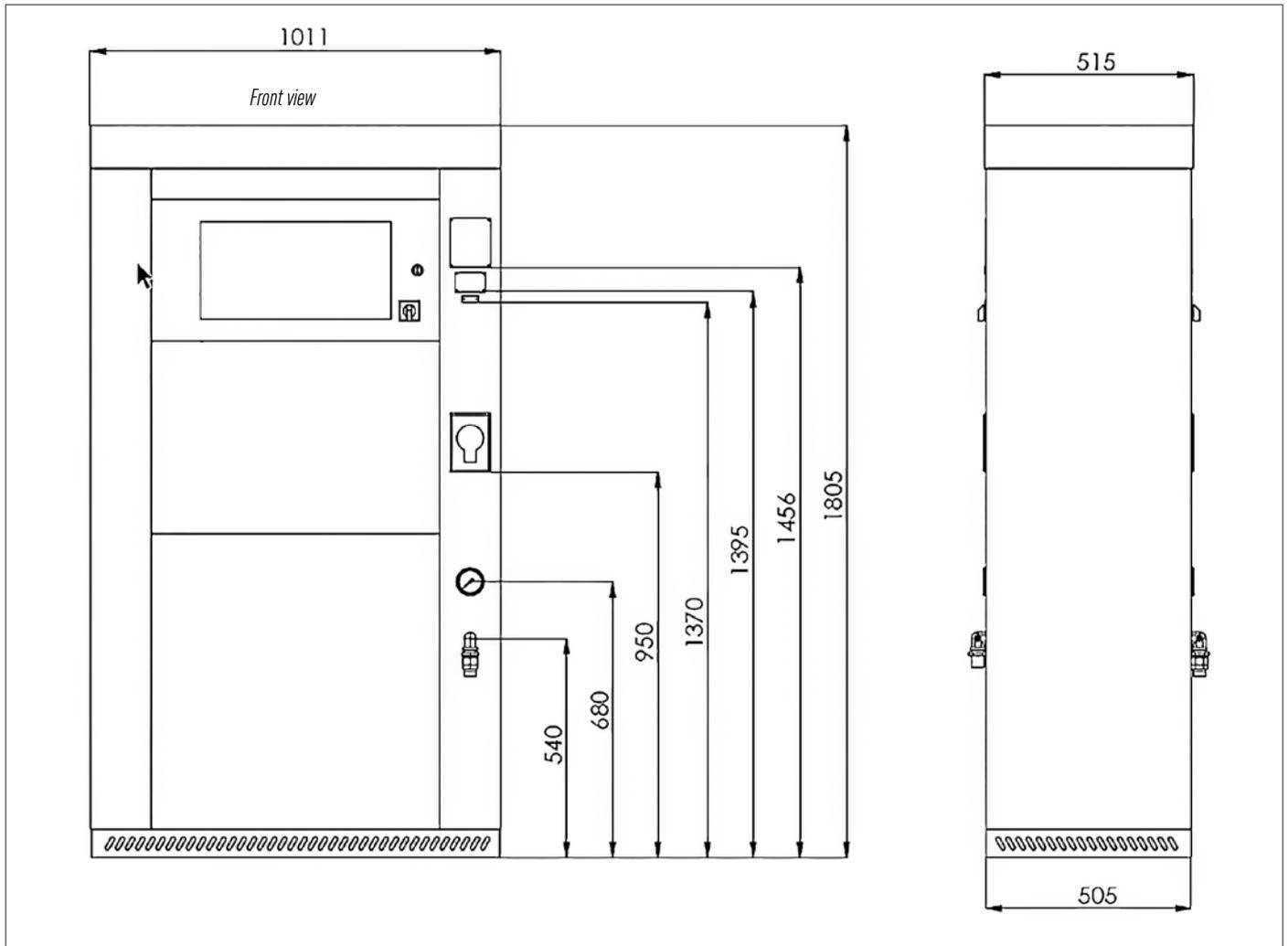

*Dimensional drawing of electronic LPG-dispenser*

### FAS 35 4739 combined electronic LPG dispenser type FAS-220 WM BC

Operation pressure, bar	up to 25
Flow capacity, l/min	
min.	5
max.	50
Weight, kg	270
Dimensions, mm:	
Height (entire dispenser)	2450
Height (mechanical part)	718
Width	500
Depth	760
Power supply	230 V AC, 50 Hz

With filling device for filling of 27- and 50-liter gas cylinders and a filling unit for filling of cars.

Counter-Display (kg)/LCD-Display	1 (inside)/1 (FAS-220) 2 (inside)/2 (FAS-230)
Hydraulic	PN 25
Equipment: vapor eliminator with fine mesh filter, differential pressure valve, back check pressure valve, safety relief valves, expansion vessel, high pressure hose LPG 19 (length 5 m) with excess flow valve and breakaway coupling	
Connection: liquid phase / gas return line	Ball valve 3/4" G IG / Ball valve 3/4" G IG
Information data at LCD-Display "price per liter", "filling volume liter", "total sum", "tare", "filling weight, kg", "total weight, kg"	
Protocols: Easy Call, DART, Pumalan, Nara	
Information data at internal counter-display: volume, kg, density and temperature data of LPG	

#### Additional equipment (against extra cost):

solenoid valve (single- or double-acting), heating for electronic part, insulating flange set for underground pipe lines

34 9331	Remote control "SERVICE" for programming
34 9330	Remote control "USER"
22 117	Heating dispenser electronics
22 7591	Preset equipment
34 0860	Automatic hose return
22 1175	LPG hose DN19



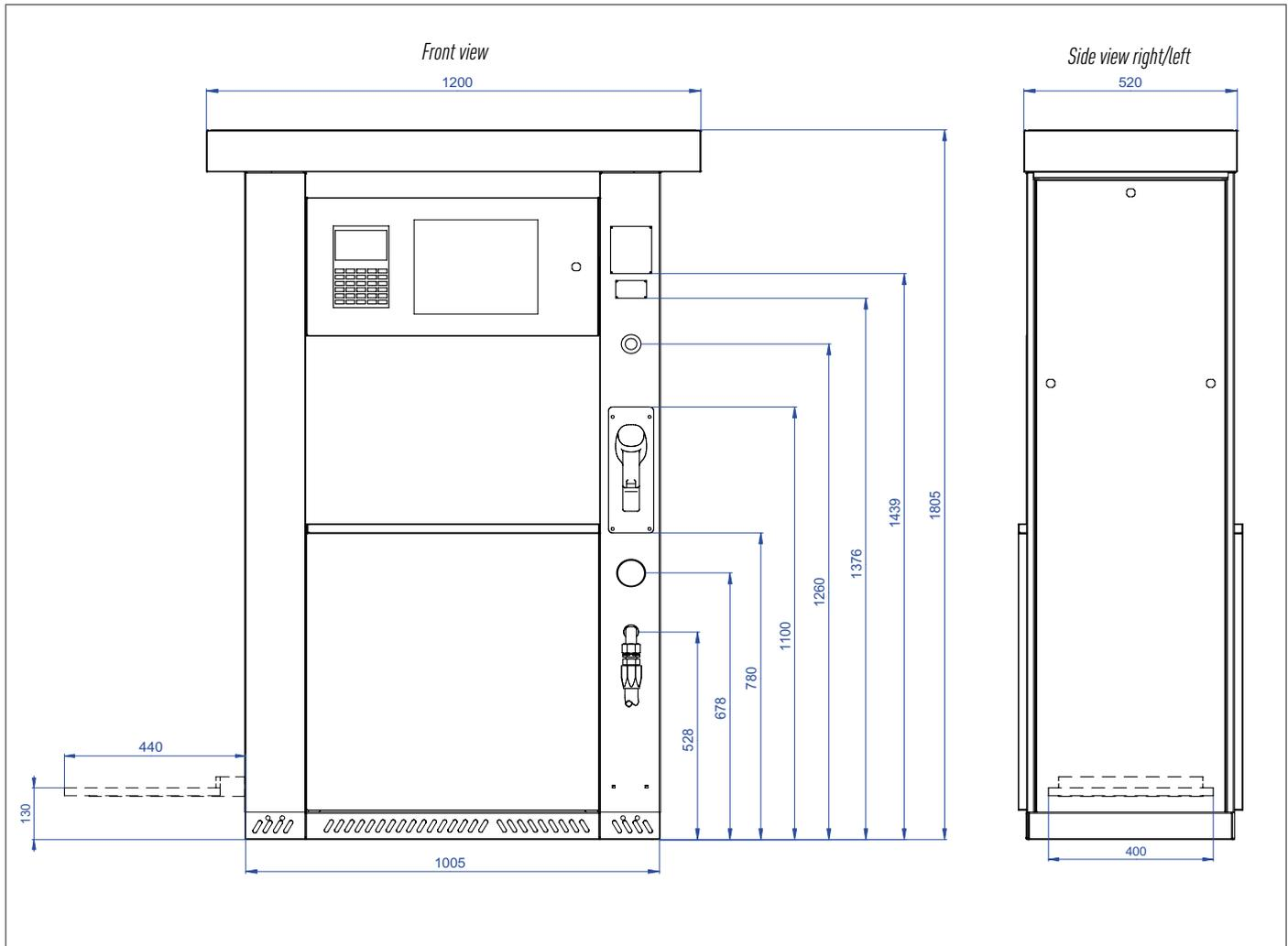

*Dimensional drawing of electronic LPG-dispenser  
type FAS-220 WM with filling device*

**FAS 93 6931 electronic LPG dispenser type FAS ZS-120 (Economy line)**

Operation pressure, bar	up to 25
Flow capacity, l/min	
min.	5
max.	50
Weight, kg	90
Dimensions, mm:	
Height (entire dispenser)	1500
Height (mechanical part)	1000
Width	500
Depth	400
Power supply	230 V AC, 50 Hz

Counter-Display (kg)/ LCD-Display	1 (inside)/1
Hydraulic	PN 25
Coriolis flow meter	5-50 l/min

Equipment: vapor eliminator with fine mesh filter, differential pressure valve, back check pressure valve, safety relief valves, expansion vessel, high pressure hose LPG 19 (length 5 m) with excess flow valve and breakaway coupling

Connection: liquid phase / gas return line	Ball valve 1" female NPT/ Ball valve 3/4" female NPT
---	--

Information data at LCD-Display: "price per liter", "filling volume liter", "total sum"

Information data at internal counter-display: volume, kg, density and temperature data of LPG

*Additional equipment (against extra cost): solenoid valve (single- or double-acting), heating for electronic part, insulating flange set for underground pipe lines*



**FAS 93 6938 Electronic LPG dispenser type FAS ZS-230 (Economy line) displays + hoses at the front**  
**FAS 93 6936 Electronic LPG dispenser type FAS ZS-230 (Economy line) displays + hoses oppositely**

Operation pressure, bar	up to 25
Flow capacity, l/min	
min.	5
max.	50
Weight, kg	148
Dimensions, mm:	
Height (entire dispenser)	1500
Height (mechanical part)	1000
Width	850
Depth	400
Power supply	230 V AC, 50 Hz

Counter-Display (kg)/LCD-Display	2 (inside)/2
Hydraulic	PN 25
Coriolis flow meter	5-50 l/min

Equipment: vapor eliminator with fine mesh filter, differential pressure valve, back check pressure valve, safety relief valves, expansion vessel, high pressure hose LPG 19 (length 5 m) with excess flow valve and breakaway coupling

Connection: liquid phase / gas line	Ball valve 1" female NPT/ Ball valve 3/4" female NPT
--	--

Information data at LCD-Display: "price per liter", "filling volume liter", "total sum"

Information data at internal counter-display: volume, kg, density and temperature data of LPG



### FAS 93 583 Service kit in a tool bag for service technicians

Service kit in a tool bag with calibrated flow turbine and set of adaptors for connection to internal filling valve. For control measuring of LPG Dispenser Type FAS-120/220/230 after.

#### Consists of:

- Tool bag
- Measuring turbine, max. flow capacity 50 l/min, with 1 3/4" ACME connections
- 1×FAS 22344 rotary switch attachment
- 1×Adapter FAS 13532, T3 / W 21,8×1/4" male
- 1×Adapter FAS 13518, 1 3/4" ACME coupling / Bajonett
- 1×Adapter FAS 13509, 1 3/4" ACME coupling / T3
- 1×Adapter FAS 10065, 1 3/4" ACME male / W 21,8×1/4" male
- Protective glove

### Conversion kit for modification of a LPG-dispenser type FAS of early versions

The conversion kit makes it possible to modify quickly an early version of LPG-dispenser with piston meter. **Consisting of:**

- 2 pcs. of Coriolis mass meter, cable, LCD-display and 2 pcs. differential pressure valves
- Installation material
- Manual



FAS No.	Description
93 602	Conversion kit for modification of dispenser FAS-230 with one 4-piston meter, year of manufacture from 2007
93 6020	Conversion kit for modification of dispenser FAS-230 with one 2 or 4-piston meter, year of manufacture before 2004
93 6021	Conversion kit for modification of dispenser FAS-120 with one 2-piston meter
93 6026	Conversion kit for modification of dispensers FAS-120/220 with one piston meter in a dispenser with a mass meter
93 6030	Conversion kit for modification of dispenser FAS-230 with two-piston meter in a dispenser with a mass meter

# Complete FAS filling station type FAS

**FAS LPG filling stations** are designed as "ready to use" units according international regulations including several engineering advantages:

- serial production
- short time for installation
- low operation cost
- full operation control
- several types of dispenser available
- several types of pumps available
- "easy to transport" design



**FAS LPG filling stations** are available in several modifications:

- LPG tanks: 1-4
- LPG tanks available volume: from 2 up to 25 m<sup>3</sup>
- LPG dispensers: 1-6
- LPG pumps: FAS-NZ, CORKEN, Blackmer, EBSRAY
- version with filling of LPG bottles available
- e-control box: customized according user specifications or FAS standard



#### Base configuration:

- Corken FD 150, Z 2000 or FAS NZ 36-8 pump units;
- bypass valve in the bypass line;
- strainer;
- complete piping;
- pressure gauges with shut-off valves;
- flanged ball valves;
- connection assemblies for gas vehicle with protective caps (liquid and vapour phases)

The station is designed and implemented according to the **block-modular principle**. Functional and technological possibilities of the filling station (fuel reserve, dispensing capacity, metering automation, etc.) can be expanded by connecting the corresponding modules without the need for large-scale construction, installation and adjustment works. These features of FAS stations make it possible to confidently compete in the complex fuel market.



LPG filling stations are available as **FAS STANDARD** or **CUSTOMIZED** according operation conditions --

**FAS 93 3093 complete FAS “ready to use” pump units**

for LPG car refueling station, prepared for installation of LPG dispenser and 1, 2 or 3 pcs of LPG tanks

**Consisting of:**

- FD-150 pump unit with mechanical seal, capacity up to 100 l/min, Ex-motor 4,6 kW, 400/690 V, 50 Hz
- supply line with ball valve DN 32 and fine filter DN 32
- discharge line with ball valve DN 25 with mounting flange
- bypass line with bypass valve and ball valve with mounting flange
- all necessary additional equipment for safety operation
- connections for road tanker

All equipment is painted. Mounted on a common galvanized frame. The frame is prepared for mounting of all types of FAS dispensers.

**FAS 93 3092 complete FAS “ready to use” pump units**

for LPG car refueling station, prepared for installation of LPG dispenser and 1, 2 or 3 pcs of LPG tanks

**Consisting of:**

- side channel pump unit with mechanical seal, capacity of 100 l/min, Ex-motor 5 kW, 400/690 V, 50 Hz,
- supply line with a ball valve DN 32 and with a fine filter DN 32
- discharge line with a ball valve DN 25 with mounting flange
- bypass line with bypass valve and ball valve with mounting flange
- all necessary additional equipment for safety operation
- connections for road tanker

All equipment is painted. Mounted on a common galvanized frame. The frame is prepared for mounting of all types of FAS dispensers.

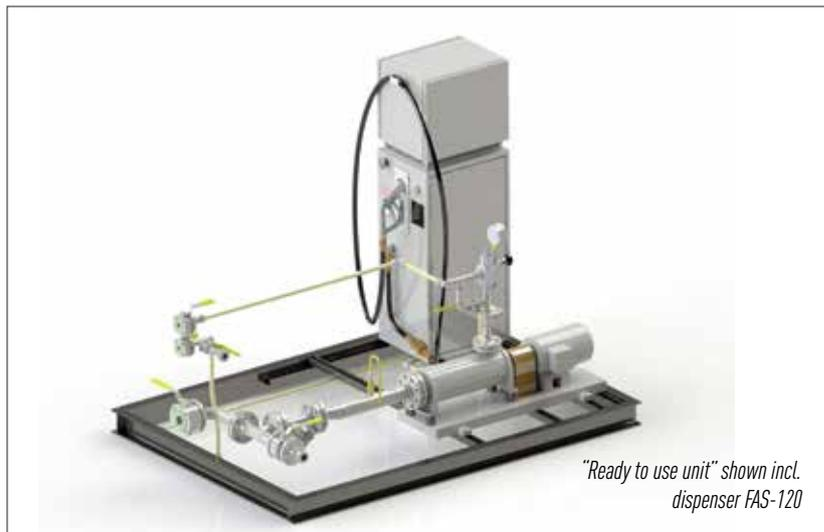

*“Ready to use unit” shown incl. dispenser FAS-120*



## Complete LPG-filling station type FAS with underground storage tanks of 4 850 up to 20 000 l

### LPG-Filling Station for filling of cars with LPG:

- Underground storage tanks
- Common steel base frame, with LPG-Dispenser, pump unit for the removal of liquid phase from the tank, incl. all the necessary safety- and shut-off fittings, strainer, by-pass valve and all necessary pipe lines
- The construction on a common frame reduces the installation and remanufacturing costs, speeds mounting and commissioning, retaining system stability.

### Main components:

- 1-3 underground storage tanks for LPG (4,85/6,7/9,0/20,0 m<sup>3</sup>)
- Complete self-priming pump facility with pump unit type FAS-AP, capacity 50/100 l/min
- By-pass line
- Pipe lines for filling of cars, filling and emptying of storage tanks, also by emergency emptying
- Dry running protection – flow detector dip sensor
- Insulating flanges for underground pipe lines
- 1-4 LPG-dispenser type FAS, with one or two filling nozzles, capacity – up to 50 l/min
- Complete measuring, shut-off and safety fittings

*"Ready to use unit" with FD-150,  
prepared for connections  
with two LPG tanks*



Execution and installation versions will be processed accordingly to country-specific regulations and standards as well as to specific customer requirements and can be combined in modular construction system if necessary.

FAS

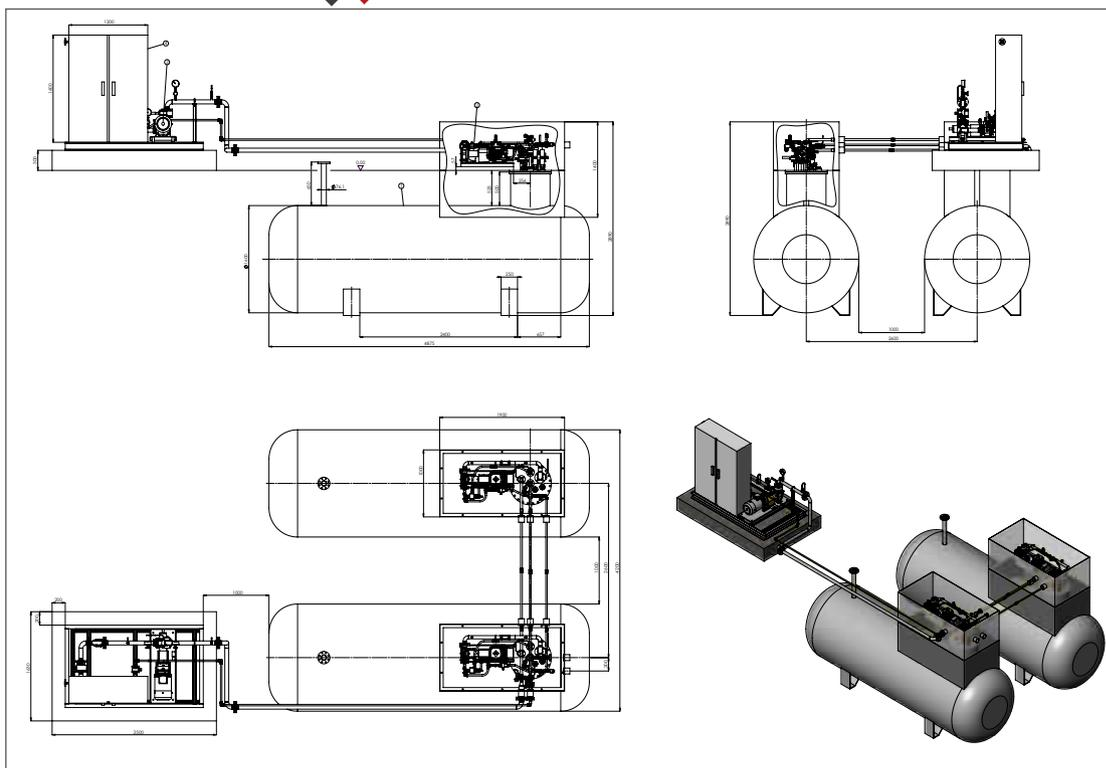

**Complete compact LPG-filling station type FAS**

with one underground storage tank

- Capacity of filling station is up to 20 cars per hour
- Completely pre-assembled and tested
- Quick installation and commissioning

Neither long construction nor mounting works are required. Only a spoil for storage tank and a trench for power supply as well as data cables are needed. Pump unit is equipped with pump FD-150, flow capacity 90 l/min at differential pressure of up to 10,5 bar and electrical motor with motor capacity 4,1 kW in Ex-execution.

**REMARK:** the execution of this compact station is possible with LPG-dispenser type FAS-220 WM



*Hydraulic schema of compact filling unit with underground storage tank and pump unit FD-150. LPG-dispenser – FAS-120.*

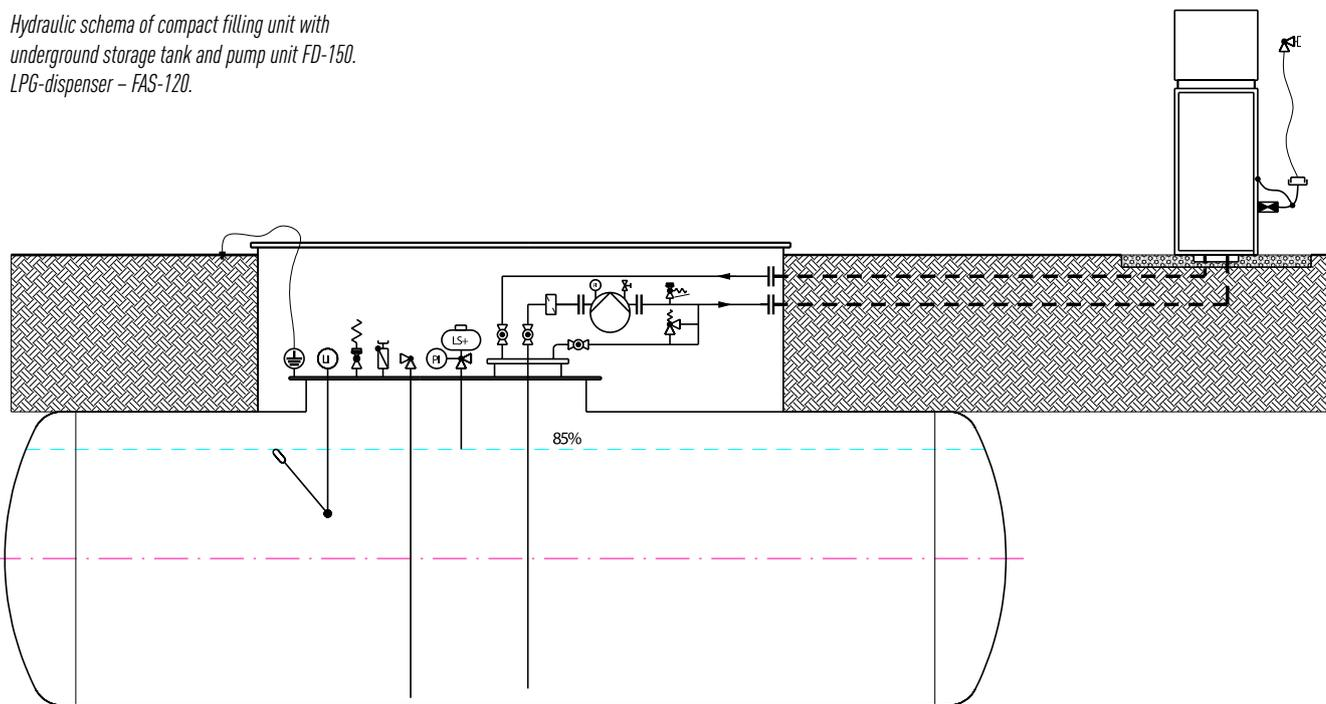

## D

## Measurement and control equipment

**Floating liquid level gauge**

- with transfer of measured values in % of tank volume

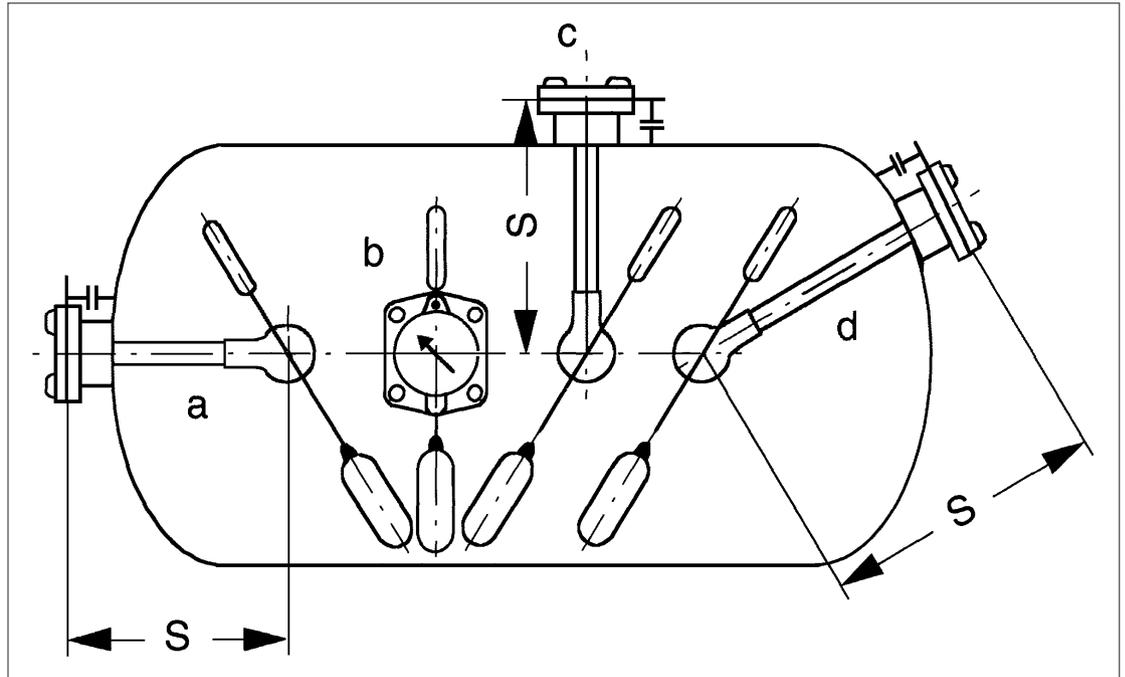
**By order must be specified:**

1. Type name: Junior, Senior, large tank version
2. Tank inside diameter
3. Tank type: cylindrical or spherical
4. Mounting position:
  - a. End mounted in tank bottom
  - b. Side-mounted in tank shell
  - c. Top-mounted
  - d. Angle-mounted in tank bottom or in tank shell
5. For dimensional determination of gauge:
  - for 4a) Stem length (S)
  - for 4b) Stem length (S)
  - for 4c) distance from center line of tank to top of mounting flange (S= stem length)
  - for 4d) degree of angle between horizontal center line of tank and center line of liquid level gauge or vertical distance in mm from horizontal center line of tank to center of gauge; distance from center of motion of liquid level gauge to top of mounting flange (S = stem length)

**Liquid level gauge PN 25, Type Junior**

- with rubber seal
- protection cup
- mounting screws M6×25 from stainless steel



FAS No.	Type Junior	Mounting position	Tank ø, mm	Shaft length, mm
18 001	6284	horizontal	up 800	≈350
18 002			up 1250	
18 003			up 1600	
18 006	Special execution for ammonia			
18 011	6281	vertical	800	630
18 012			1000	510
18 013			1250	630
18 014			1250	755
18 015			1250	785
18 016			1250	805
18 017			up 1600	up 1200
18 019	Special execution for ammonia			

**Liquid level gauge PN 25, Type Senior**

- with rubber seal
- protection cup
- mounting screws M6×25 from stainless steel

FAS No.	Type Senior	Mounting position	Tank ø, mm	Shaft length, mm
18 021	6283	horizontal	up 1600	≈200
18 031	6280	vertical	up 1500	up 825
18 032			up 2000	up 1200

**M6300 series Magnetel gauges**

- special design for mobile applications such as truck, trailer, container

Model	Mounting	Model	Mounting
6339 M11	Side, End 45°	6342 M12	Side, End 45°
6342 M11		6339 M16	
6339 M12		6342 M16	

### Liquid level gauge large tank version for horizontal cylindrical tanks

- horizontal installation
- 8" dial
- spiral wound gasket 1.4571/graphite to 550°C
- screws M12×25 from stainless steel

#### Executions:

- A – for propane/butane, Type W709, flange PN 40, from 1.4541
- B – for propane/butane und ammonia, flange PN 25, from stainless steel
- C – for propane/butane, Type W709, with spring shock absorber for road tankers, shaft length – 475 mm, side mounting, flange PN 40, from 1.4541

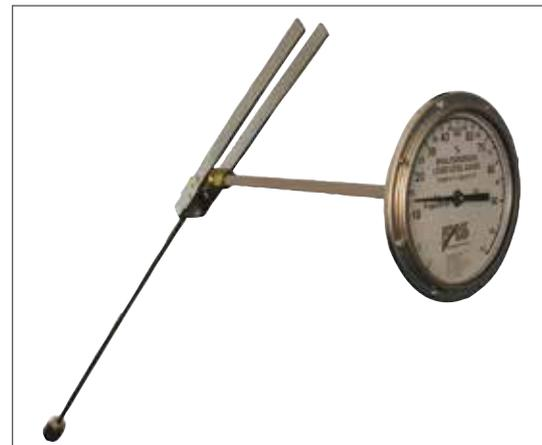

FAS No.	Tank ø, mm	Shaft length, mm
<b>Execution A</b>		
18 071	1600	610
18 072	1900	610
18 073	2000	610
18 074	2100	610
18 075	2200	610
18 076	2300	610
18 077	2400	610
18 078	2500	610
18 079	2700	610
18 080	2800	610

FAS No.	Tank ø, mm	Shaft length, mm
18 081	2900	610
18 082	3000	610
18 083	3200	610
18 084	3400	610
18 085	3500	610
18 086	3600	610
18 087	3800	610
18 088	4000	610
18 094	Additional price – alternativ tank Ø or shaft length	
<b>Execution B</b>		
18 167	up 2500	610
18 168	up 3000	610

FAS No.	Tank ø, mm	Shaft length, mm
18 169	up 3600	610
18 170	up 4000	610
<b>Execution C</b>		
18 100	2000	without shaft (side mounting)
18 101	2100	
18 102	2200	
18 103	2150	
18 104	2050	
18 105	1900	
18 106	2250	
18 107	1800	
18 108	1750	

### Liquid level gauge – large tank version for horizontal cylindrical tanks

- type Rochester
- 4" dial
- spiral wound gasket 1.4571/graphite to 550°C
- screws M12×25 from stainless steel

*Level gauges – large tank version with dial 4" for ammonia (NH) on your request*

FAS No.	Mounting position	Tank ø, mm	Shaft length, mm
18 330	Horizontal	up 2000	610
18 331		up 2500	610
18 332		up 3000	610
18 333	Vertikal	up 2000	up 1250
18 334		up 2500	up 1550
18 335		up 3000	up 1800
18094	Additional price – alternativ tank Ø or shaft length		

### Liquid level gauge – large tank version for horizontal cylindrical tanks

- vertical installation
- 8" dial
- spiral wound gasket 1.4571/graphite to 550°C
- screws M12×25 from stainless steel

#### Executions:

- A – for propane/butane, Type S709 (max. shaft length – 2500 mm, other lengths – on your request), flange PN 40, from 1.4541
- B – for propane/butane und ammonia, flange PN 25, from stainless steel

FAS No.	Tank ø, mm	Shaft length, mm
<b>Execution A</b>		
18 140	1600	980
18 141	2000	1100
18 142	2300	1330
18 143	2500	1350
18 144	2500	1380
18 145	2500	1400
18 146	2500	1430
18 147	2500	1450
18 148	2500	1550
18 149	2500	1650
18 150	2600	1540
18 151	2600	1590
18 152	2900	1550
18 153	2900	1580

FAS No.	Tank ø, mm	Shaft length, mm
18 154	2900	1600
18 155	2900	1650
18 156	3000	1530
18 157	3000	1635
18 158	3200	1750
18 159	3400	1850
18 160	3600	1800
18 161	4000	2085
18 094	Additional price – alternativ tank Ø or shaft length	
<b>Execution B</b>		
18 172	up 2500	up 1550
18 173	up 3000	up 1800
18 174	up 3600	up 2300
18 175	up 4000	up 2300

### TDR-Sensor

for continuous liquid measurement of filling level and of separator

- filling level sensor VEGAFLEX 81 for mounting in tank
- switch amplifier type VEGAMET 381 for continuous measurement with integrated limit switches
- for installation in electrical switch box
- filling level measurement of LPG in tank in the real time
- control of minimum and maximum values of tank filling (for example 5/85%) with supply control signal for switching off of pump motor or of solenoid valve control at reaching of minimum or maximum filling level



FAS No.	Execution
26 0855	Level sensor VEGAFLEX 81 with built in display-operation module (PLICSCOM), EX ia IIC T1..T6 X, thread G¾, material 316L
26 182	Switch amplifier type VEGAMET 381 for filling level sensors, Inlet: 1×4-20 mA, Outlet: 1×0/4-20 mA – current outlet, 2×Relay outlets, 1×device defect relay, operating voltage: 20-253 V AC, 50/60 Hz, error of indication-accuracy±20µA (0,1% from 20mA), number of relay outlets 2×operation relays, 1×device defect relay, LC display for digital and analog presentation of measured value, ambient temperature -20...60°C, protection art IP 40
26 087	VEGACONNECT 3 interface adaptor between PC and communicable VEGA devices

**Devices for „dry running protection“ of pumps**

- no mechanical parts, full electronic version
- for use in Ex-Zone 1

FAS No.	Execution	Weight, kg
18 381	Flow detector analyzing device for connection to sensor, EExib II C, operating voltage 230 V/50 Hz AC, relay output: 1, for installation in electrical switch box	0,3
18 380	Flow detector analyzing device for connection to sensor, EExib II C, operating voltage 24 DC, relay output: 1, for installation in electrical switch box	0,3
18 384	Flow detector analyzing device with connection 1/2" NPT AG, EExib II C, Operating voltage 24 V DC, version: Eurocard-size 100x160 mm	0,3
18 382	Flow detector dip sensor for use in hazardous areas, case form stainless steel A4, art of protection IP68, with 2 m connection cable, ambient temperature -20 °C up to +85 °C, max. pressure – 60 bar	0,2
18 389	Welding half coupling 1/2" NPT, PN 40, for dip sensor, from steel ASTM 105	0,1

**Gas withdrawal valve with limit indicator PN 25 for LPG storage tank**

- case from brass
- tank connection 3/4" NPT-AG
- gas withdrawal connection POL-IG
- complete with pressure gauge, gauge and dip tube

FAS No.	Type	Dip tube, mm	Weight, kg
18 024	489	250	1,5
18 025	489	310	1,5
18 026	489	463	1,5

**Adaptor PN 40, for dip sensor**

- for installation between two flanges
- material – steel H II

**Executions:**

- A – connection for sensor 1/2" NPT-IG
- B – connection for sensor 1/2" NPT-IG and additional connection 1/4" NPT-IG for one safety relief valve



FAS No.		Nominal width, DN	Weight, kg
Execution A	Execution B		
18 390	18 680	15	0,3
18 391	18 681	20	0,5
18 392	18 682	25	0,7
18 393	18 683	32	0,9
18 394	18 684	40	1,1
18 395	18 685	50	1,5
18 396	18 686	65	2,0
18 397	18 687	80	2,3
18 398	18 688	100	3,0
18 399	18 689	125	3,6
18 400	18 690	150	4,2

**Flow indicator PN 25**

- connection 2" NPT-AG
- for pipe diameter 50 up to 100 mm

**Sight flow indicator PN 25**

- NPT- female thread
- case from ductile cast iron ASTM 536
- back check valve from stainless steel
- with two opposing glasses



FAS No.	Length, mm	Weight, kg
18 440	55	0,9
18 441	75	0,9
18 442	125	0,9
18 444	4" dial (spare part)	

FAS No.	RegO	Connection, "	Weight, kg
18 501	A7794	2	4,7
18 502	A7796	3	10,0

**Vent valve PN 40**

- 1/2" NPT-male thread

**Executions:**

- A – with type approval
- B – with knurled screw
- C – with tee handle



FAS No.	Type	Execution	Warning plate	Dip tube	Material	Picture
18 430	FAS 7155	A, B	-	-	Brass	1
18 431	RegO 3165 C	B	-	-		1
18 432	RegO 3165 CP		+	-		2
18 433	RegO 3165 CF		-	300 mm		5
18 434	RegO 3165 CPF		+	300 mm	4	
18 438	FAS AL 1917	C	-	-	Steel	1
18 435	RegO TSS 3169		-	-	Stainless steel	3
18 436	RegO TA 3169 F		-	300 mm	Steel	5



**Pressure switch**

- explosion protected
- EEx ed IIC T6
- connection G1/2" AG
- protection art IP 55
- ambient temperature -20 up to +40°C
- changer protected against explosions
- switching capacity – 0,5 A 230 V AC
- control button is mounted inside; PTB approval

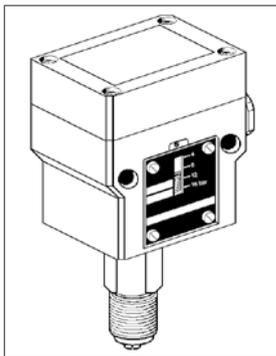

FAS No.	Type	Range, bar	Difference, bar	Max. testing pressure, bar	Weight, kg
18 461	Ex/FF 142V-3	-0,4...8,0	0,3...3,0	25	1,2
18 460	Ex/FF 142V-10	5,0...40,0	2,0...10,0	50	1,2

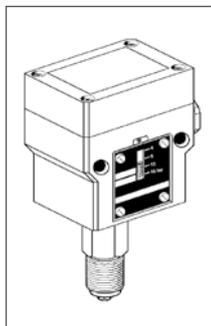
**Pressure switch**

- Ex-i proof, protection art IP 54
- connection G1/2" AG
- case from aluminium
- max. admitted pressure – 25 bar
- ambient temperature -25 up to +70°C
- 1 changer
- switching capacity – 5/230 V AC
- Ex-proof when used in conjunction with isolating switch amplifier FAS No. 25301 (230 V) or 26303 (24 V)

**Pressure switch**

- Ex-i proof, protection art IP 54
- connection G1/2" AG
- case from Aluminium
- max. admitted pressure – 25 bar
- ambient temperature -25 up to +70°C
- 1 changer
- switching capacity – 5/230 V AC
- Ex-proof when used in conjunction with isolating switch amplifier No. 25301 (230 V) or 26303 (24 V)



FAS No.	Type	Range, bar	Difference, bar	Weight, kg
184573-EU/18457-CIS	DWR 625	0,5...6,0	0,25	0,3
184560-EU/18456-CIS	DWR 25	4,0...25,0	1,00	0,3
184621-EU/18462-CIS	DCM 6	0,5...6,0	0,15	0,3

**Maximal Pressure control switch**

- acc. To TRB 801/25, without Ex-proof, protection art IP 65
- connection – G1/2" AG, 1 changer
- max. admitted pressure – 25 bar, setting range 3-16 bar
- ambient temperature -25 up to +60°C
- Ex-proof when used in conjunction with isolating switch amplifier No. 25305 (230 V)

FAS No.	Type	Execution	Weight, kg
18 453	FD 16-326	External electrical locking system required in switch box	0,6
18 454	FD 16-327	With mechanical locking device	0,6
26 301/302	KHA6-SH-EX1	Isolation switch amplifier in safety engineering, intrinsically safe control circuit, supply voltage 230 V / 50 Hz	0,1



### Sight flow indicator PN 25

- socket connection  
NPT-female thread
- housing from steel casting  
GS-C 25
- with two opposite glasses

FAS No.	Connection, "	Length, mm	Weight, kg
18 503	½ NPT	100	2,8
18 504	¾ NPT	100	2,8
18 505	1 NPT	130	5,6
18 506	1¼ NPT	130	5,6
18 507	1½ NPT	150	6,0
18 508	2 NPT	180	9,5



### Sight flow indicator PN 25

- flange connection acc. to  
DIN 2635
- housing from steel casting  
GS-C 25 with two opposite  
glasses from borosilicate  
glass acc. to DIN 7080

FAS No.	Connection (DN)	Length, mm	Weight, kg
18 588	15	150	3,5
18 589	20	150	4,5
18 590	25	160	5,5
18 591	32	180	8,0
18 592	40	200	9,0
18 593	50	230	11,0
18 517	65	290	16,0
18 518	80	310	21,0
18 519	100	350	27,0
18 509	125	400	38,0
18 510	150	480	50,0
92 662	200	400	111,



### Spare parts for rotary level gauges

*Other spare parts are available on  
request*

FAS No.	Type	Description	Material
18 545	A3163-6	Screw plug with seal	Steel
18 546	FAS		
18 547	FAS	Dial	Alu
18 548	Reg0		



### Rotary level gauge PN 25

- material – steel
- for horizontal tanks; connection – 1" NPT-AG
- complete with dial and rotary level gauge for stationary and mobile tanks

FAS No.	Type (RegO)	Stem length, mm	Stem execution	Weight, kg
18 531	A9091 R	490	Standard stem	1,7
18 533	A9092 R	675		2,0
18 535	A9093 RS	915		2,3
18 536	A9093 TS	915	Reinforced stem	3,0
18 537	A9094 TS	1150		3,5
18 530	A9095 TS	1422		3,8

### Dip tube for rotogauge

- material – steel
- $\varnothing$  8 mm
- one side with thread
- order number – 28 119



### Turbine flow meter PN 40 for LPG

- 6 digit LCD-display with floating point
- installation independent on location
- various measuring options: total sum, sub-total (resettable)
- current flow rate in l/min
- lithium battery (approx. 4.000 operation hours); automatic switching on and off
- not calibratable



FAS No.	Connection	Accuracy of measurement, %	Measuring range, l/min	Temperature range, °C	Dimensions, MM	Weight, kg
18 326	1/2" NPT	±2	4...40	10...60	110×50×55	0,9
18 325	2" NPT		80...800		160×85×100	2,5
18 385	1" NPT		2...200		115×50×70	1,2
18 388	ISO G3/4"		8...80		110×50×70	1,1



Version without printer



Version incl. printer



Version with TEX-Register

### Complete measuring unit Type LC

- flow direction from left to the right
- BUNA seals
- include fastening base without ground plate
- execution for road tanker:
  - type MA-4 up to MA-15 – housing from alu
- execution for stationary units:
  - type MSA-15 up to MSA-120 – housing from steel

**Equipment:** Back check pressure valve in inlet (standard for MA-4 – MA-7), vapor eliminator with fine mesh filter, LC-Meter, mechanical counter Type VR with ticket printer, differential pressure valve. Combination options, spares and conversion parts on special request: electronic counter with ticket printer, flow direction from right to the left, with DIN-flanges, with pulser etc.

FAS No.	Type	Connection	Capacity, l/min	Operation pressure, bar	Housing	Execution	Weight, kg
---------	------	------------	-----------------	-------------------------	---------	-----------	------------

#### Execution for road tanker

18 792	FAS-LC MA 5GX 10	1½"	20...227	25	Alu	without temperature compensation	37,0
18 7935	FAS-LC MA 7GX 10	2"	75...380	25		without temperature compensation	44,0
18 7936	FAS-LC MA 7GX 10	2"	75...380	25		without temperature compensation and without printer	43,0
98 1657	FAS-LC MA 7 TEX	2"	75...380	25		with TEX register	46,0
98 1642	FAS-LC MA 15 TEX	3"	150...757	25		with TEX register	46,0

### Main components of measuring units

FAS No.	Description
38 395	Differential valve for LC meter, 2"
98 930	Electronic calculator type ME 3000
98 9303	Electronic calculator for ME 4000
98 1631	TEX register
38 466	Epson Slip printer TM-U295, 24 V DC
38 4120	Trap with strainer (MID400-Version)

FAS No.	Description
38 412	Trap with strainer (LC-Version)
38 444	Back check valve
98 6570	Coriolis mass flow meter DN 40/1½"
38 459	3-way solenoid valve
38 334	Impulse line for LC measuring units

**FAS 98 1680****Measuring unit MID800-TEX**

for LPG terminals and other LPG applications. The MID800-TEX unit is characterized by various advantages:

- measurement in mass (kilograms) and volumetric (liters);
- possibility of current accounting of density and temperature;
- delivery ticket free to configure;
- data transmission via MODBUS;
- remote control operation;
- external communication via serial cable, Ethernet, Bluetooth, Wi-Fi;
- big colored LCD-display;
- capacity up to 800 l/min;
- a large selection of operating languages;
- Inlet 3" NPT / Outlet 2" NPT F;
- TEX electronic register in Ex d design;
- designed for LPG (propane-butane), execution for other liquids – on request.



Measuring unit MID800-TEX consists of the following main components:

- *air separator incl filter;*
- *check valve;*
- *PROMASS mass flow meter;*
- *differential valve;*
- *pre-set equipment;*
- *printer for delivery tickets;*
- *solenoid valves (2 pc);*
- *base frame;*
- *TEX electronic register mounted on the plant;*
- *30 meters cable for data transfer to a remote printer;*
- *electric block for connecting 230 V AC and converting 24 V DC.*

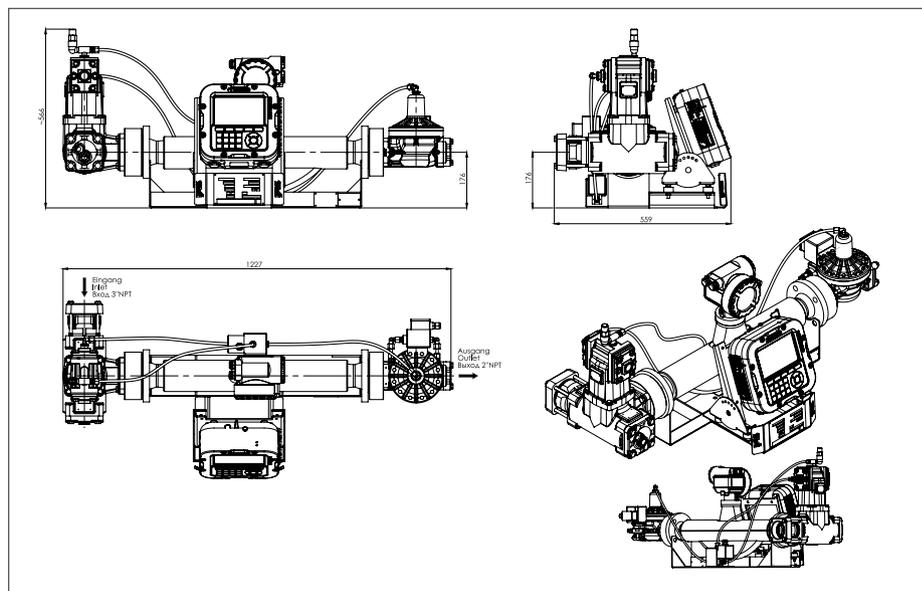

### MID-TEX measuring unit for LPG road tankers and LPG applications

- flexible configuration
- compact design
- big coloured display
- Coriolis mass flow meter
- data transfer via MODBUS possible
- LPG filling in mass (kg) and/or volume (l)
- density monitoring
- free to configure delivery ticket
- "app" data transfer
- remote control operation, external communication via serial cable, Ethernet, Bluetooth and WiFi
- Ex d-design of TEX register



### FAS 98 1631 TEX Register

could be used in measuring systems for the following liquids:

- petrochemical business: crude oil, liquid hydrocarbons, industrial oil, LPG ect
- liquid food
- alcohol, ethanol ect
- chemical product in liquid forms
- distilled water, deionized water ect
- other liquids not listed

**Please note:** TEX-Register could be combined with

- all coriolis meters with MODBUS communication
- all liquid controls PD meters equipped with pulser

FAS-Nr	Country-design	Version
98 1623	Germany	MID 400
98 1624	France	MID 400
98 1625	Turkey	MID 400
98 1626	Russia	MID 400
98 1627	Ukraine	MID 400
98 1628	Poland	MID 400
98 1629	Czech Republic	MID 400
98 1630	Kazakhstan	MID 400
98 1614	nv	MID800
98 1641	nv	MA7-TEX
98 1642	nv	MA15-TEX
98 1720	nv	MID 400
98 9303	nv	ME 4000 MID 400

*Design for other countries by request available*



### Coriolis mass flow meter for LPG

- measures in real time, independent of physical characteristics of fluids
- mass flow meter especially designed for analyses of viscosity, density, temperature and mass
- sparkling measuring accuracy, recording of several process sizes: mass flow density and temperature of fluids and gases
- cost-efficient, space-saving and maintenance free construction: no moving parts or seals
- incompatible with all established communication-protocols: HART, PROFIBUS DP / PA, MODBUS, etc.
- high anti-vibration stability, for example for operation on road tankers

For other mediums – on special request

FAS No.	Type	Connection DN	Max. measuring range, l/min (by LPG-applications)	Mediation
98 8624	PROMASS 80E	15	180	HART, frequency output; analog input/output
98 8625	PROMASS 83E			Modbus+RS485, frequency output; analog input/output
98 650	LPG-MASS	15	130	Modbus+RS485, frequency or puls output
98 8612	PROMASS 80E	25	500	HART, frequency output; analog input/output
98 8613	PROMASS 83E			Modbus+RS485, frequency output; analog input/output
98 8614	PROMASS 80E	40	1268	HART, frequency output; analog input/output
98 8615	PROMASS 83E			Modbus+RS485, frequency output; analog input/output
98 8616	PROMASS 80E	50	1950	HART, frequency output; analog input/output
98 8617	PROMASS 83E			Modbus+RS485, frequency output; analog input/output
98 8618	PROMASS 80E	80	5075	HART, frequency output; analog input/output
98 8619	PROMASS 83E			Modbus+RS485, frequency output; analog input/output
98 8689	PROMASS F300	50	1150	Modbus+RS485, frequency output
98 6570	LPG-MASS	40	720	Modbus+RS485, frequency or puls output
98 6572	LPG-MASS	50	1150	Modbus+RS485
98 656	LPG-MASS	25	360	Modbus+RS485, frequency or puls output



### Measuring unit MID 400 – ME 4000

with following main components:

- gas separator with filter screen
- check valve at the inlet
- LPG mass DN 40
- pressure relief valve
- connections 2" NPT
- printer
- preset equipment

flow direction from left to right

### Electronic calculator ME 4000:

- mounted on meter
- basic software
- mounting base for printer
- ambient temp: -25/+55°C
- input voltage: 24 V DC
- ATEX+MID approvals

FAS No.	Description
98 1720	MID 400
98 9303	ME 4000

### FAS 93 9352 complete support-measuring unit

For draining of road tankers and business commercial registration of mass and/or volume devices (under consideration of real density and temperature of LPG), PN 25

- capacity up to 220 l/min
- steel sheet cabinet – 1200×1200×600 mm
- connections M60×4 (left) with ball valve
- 2-digits LCD display
- return pipe line – RVS 22 mm
- medium temperature – 50 up to 125°C
- pump unit – FAS-Z 200 (220 l/min), mass flow meter – Promass 80E
- measuring data – density, temperature, flow
- totalizing counter for volume or mass



### Test unit for verifying your metering equipment

- max. flow – 1000 l/min
- connection: In / Out – 1 3/4" ACME
- power supply – 230 V or 24 V
- coriolis mass flow meter
- electronic counter
- totalizer "kg" and "liter"
- density measurement



### FAS 93 9359 measuring unit in a cabinet construction

- steel sheet cabinet – 2000×1600×500 mm
- medium temperature – 50 up to 125°C
- in- and outlet connections flange DN 20 with ball valve
- 4-digits LCD display
- return pipe line – RVS 22 mm
- vapor eliminator with filter
- differential pressure valve
- complete shut-off and safety fittings
- mass flow meter – Promass 83E
- Modbus RS 485-interface
- power supply 230 V
- measuring data – density, temperature, flow
- totalizing counter for volume or mass



FAS No.	Measuring rate, l/min	Maximum working pressure, PN	Inlet / Outlet	Voltage, V	Weight, kg
98 6858	10-110	25	DISCH / Ermeto 22 mm	24/230	26
35 8301	20-1000	25	1 3/4" ACME AG	24/230	50



**FAS 93 1053 complete measuring line**

- capacity up to 2500 l/min
- 2-digits LCS display
- in- and outlet connections flange DN 100
- power supply – 230 V
- measuring data – density, temperature, flow
- totalizing counter for volume or mass

**Consisting of following main components:**

- strainer
- sight flow indicator
- vapor eliminator
- mass flow meter
- solenoid valves; ball valves; liquid level sensors

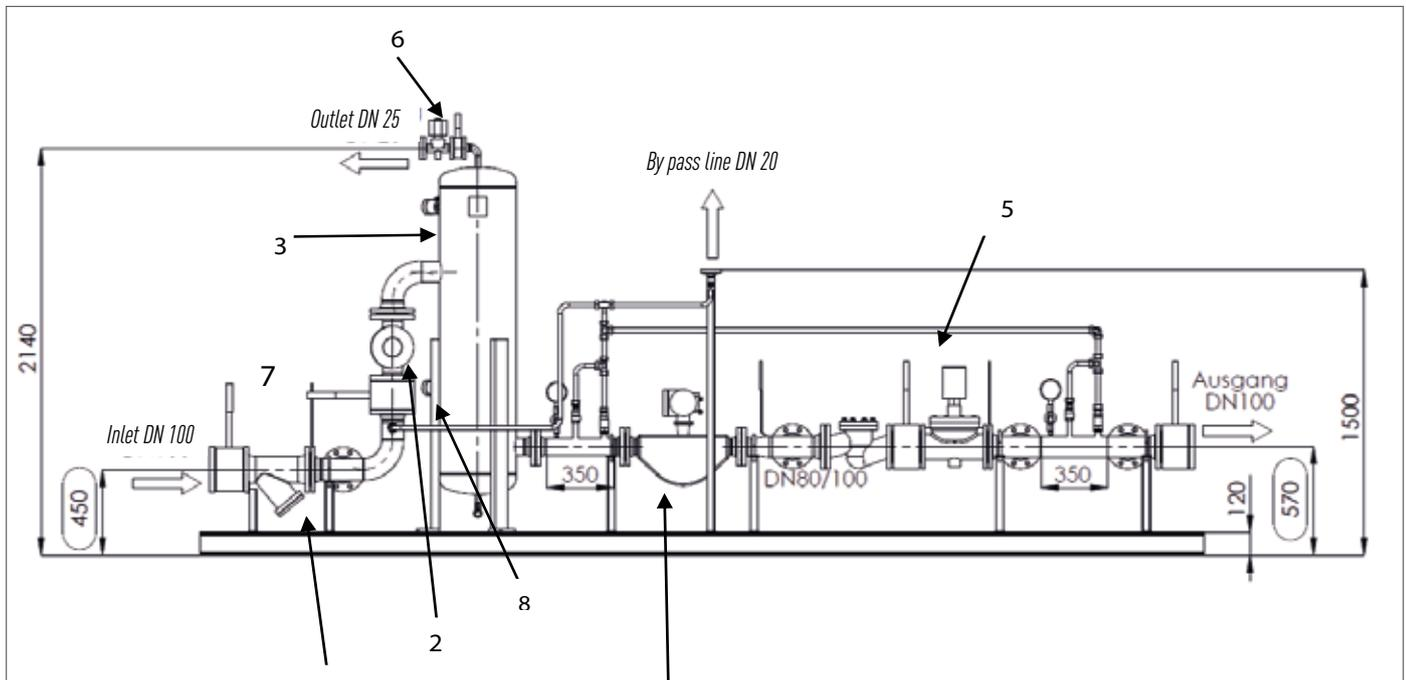
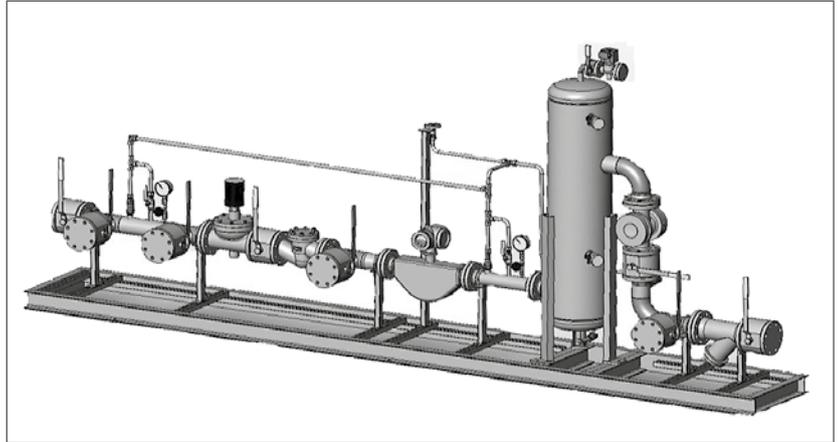

*Drawing scheme FAS 93 1053 complete measuring line*



## Accessories and spare parts for measuring systems

FAS No.	LC code	Description
38 376	A8340A	Vapor eliminator LC-SAMPI
38 3600	-	Filter type FAS for MID400 and MID400-TEX
38 360	A2343A	LC-SAMPI filter for MA7 units
38 3601	-	Filter element type FAS for MID400 and MID400-TEX
38 3751	FA7-80	Filter element LC-SAMPI for MA7 units (80 mesh SS)
98 6579	LPGMass	Coriolis meter LPGMass, DN 40
98 861	PROMASS	Coriolis meter PROMASS, DN 50
38 395	A2843	LC-SAMPI differential valve for MA7, MA15, MID400 and MID400-TEX

FAS No.	LC code	Description
38 444	A2885	LC-SAMPI check valve for MA7, MA15, MID400 and MID400-TEX
93 1920	-	Preset equipment type FAS for MID400/MID400TEX
98 1631	TEX	TEX electronic register (flow computer)
98 930	ME 3000	ME3000-electronic register
38 466	-	Printer EPSON TM-U295, 24 B
38 459	-	3-way solenoid valve
20 4360	-	2/2-way solenoid valve Magnetventil
98 1801	for MID 400 TEX	Temperature sensor PT 100 with calibration certificate
98 180	for MID 400 TEX	Temperature sensor PT 100 without calibration certificate

## E

## Vaporizers • Vaporizer units • Mixturing units

**FAS vaporizers will be assembled generally as a facility and will be delivered as a complete ready unit.**

Vaporizers and their components (trap, regulator etc.) will be mounted on a base frame, in a lockable vertical cabinet or container. This simplifies the selection of installation place both internally and externally. The regulation of the connecting pipe lines may vary depending on type, constellation and customer requests.

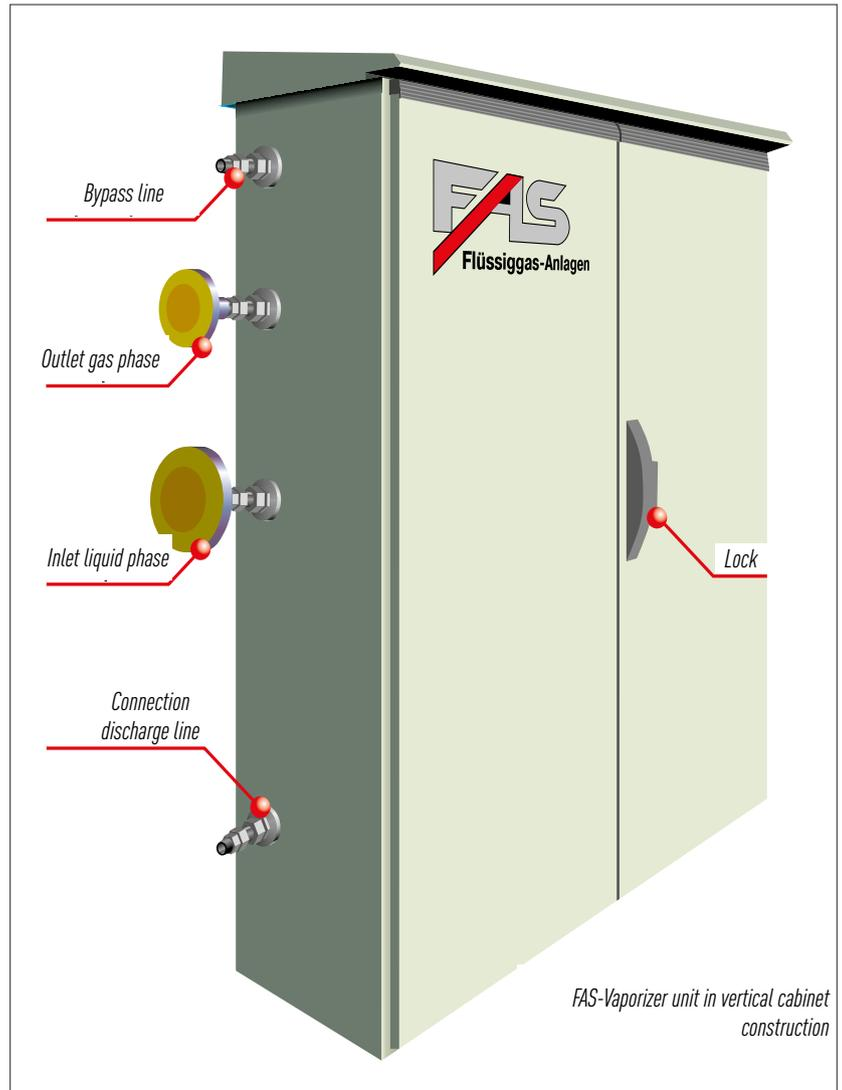

Vaporizers FAS 2000 are so called „Dry type vaporizers“ with indirect heating. An aluminium core with high heat conductivity is used as the heat transfer medium. This ensures short warm-up and reaction time.

The control of solenoid valves and of the heating will be realized means of temperature sensor on aluminium block, hereby safety operation of the unit will be ensured.

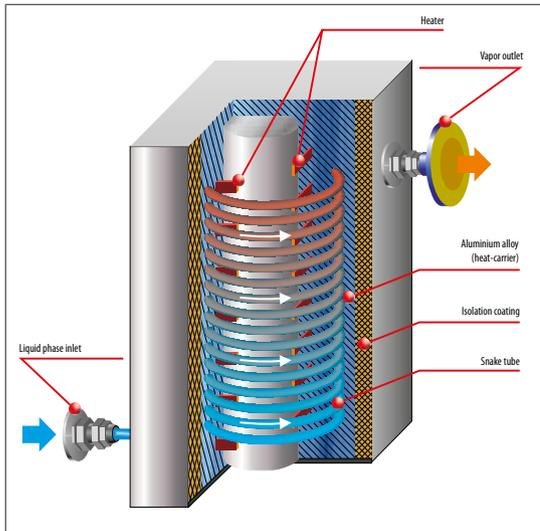

Operating diagram of dry type vaporizer FAS 2000

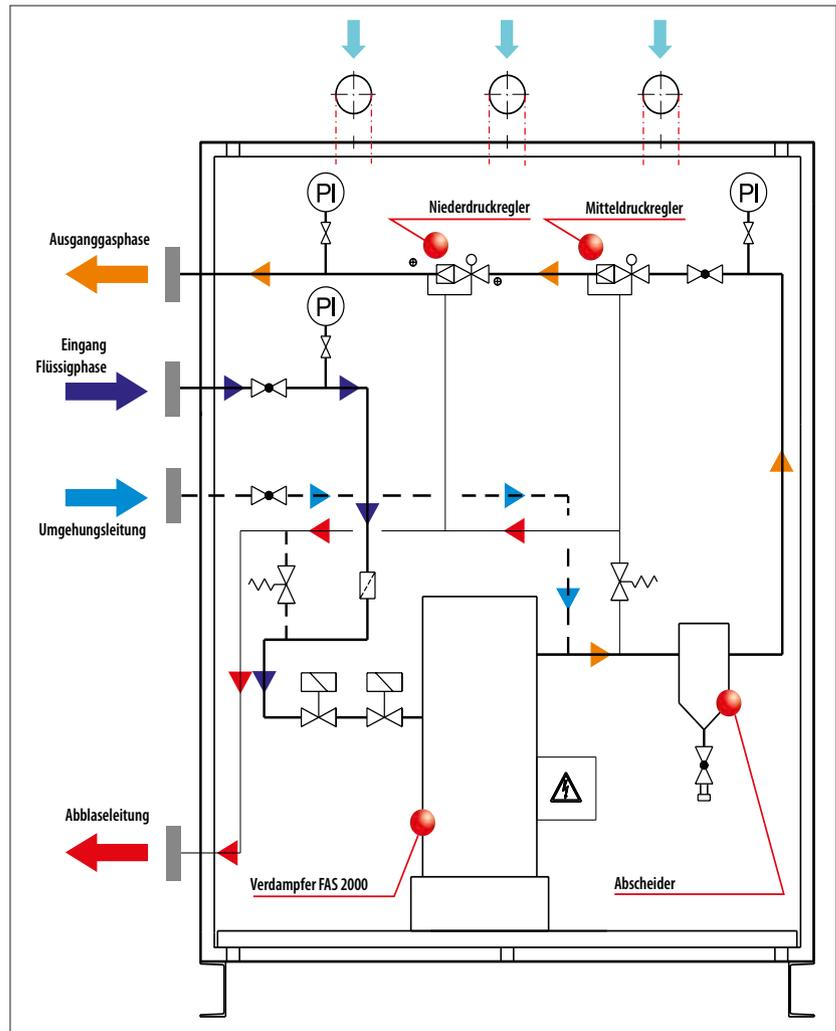

Typical diagram of vaporizer unit FAS 2000

### Electrical dry type vaporizer FAS 2000

- electrical dry type vaporizer
- capacity – 15 kg/h
- gas temperature outlet – max. 70°C
- connection value – 4,4 kW (230 V, 14 A)
- max. operation pressure – 25 bar
- pipe screw connection
- inlet/outlet – 12 mm
- wire cross section – min. 2,5 mm<sup>2</sup>
- height – 350 mm
- weight – 25 kg

FAS No.	Vaporizer type	Capacity, kg/h
20 3334	FAS 2000-15	15
20 3339	FAS 2000-25	25
20 3320	FAS 2000-40	40
20 554	FAS 2000-32	32
20 555	FAS 2000-60	60
20 556	FAS 2000-100	100
20 640	FAS 2000-170	170

### Vaporizer Type FAS 2000 in a special industrial version

Will be used in nuclear industry, biogas production, technological production lines of a high degree of reliability, industrial testing facilities.

#### Main features:

- automated temperature control of the vapor phase in the specified parameters
- transfer of operating data
- "app" communication

FAS No.	Vaporizer type	Capacity, kg/h
20 574	FAS-2000 i-32	32
20 575	FAS-2000 i-60	60
20 576	FAS-2000 i-100	100
20 577	FAS-2000 i-170	170
47 0888	e-control box*	

\* mandatory for vaporizers in industrial version



### Complete vaporizer units

Complete vaporizer units in cabinet construction ready for connection and consisting of:

- strainer in front of vaporizer (liquid line)
- liquid gas trap with possibility to install liquid level sensor
- regulator group (modification with duplication is possible)
- shut off fittings
- pressure gauges
- reserve gas line

Complete unit mounted in a steel cabinet and is ready for connection directly after the installation

Model	FAS-No.	Capacity, kg/h	Inlet/Outlet, Ø mm	Cabinet dimension, B×L×H, mm	Weight, kg
FAS 2000-40	20 3381	40	DN 25/ DN 25	400×800×1200	140
FAS 2000-32	20 977	32		400×1200×1200	215
FAS 2000-60	20 648	60		400×1200×1200	265
FAS 2000-70	20 3382	70		400×1200×1200	233
FAS 2000-100	20 986	100	DN 25 / DN 50	400×1600×1200	352
FAS 2000-170	20 322	170		400×1600×1200	361



**Premium serie LPG vaporizer unit FAS 2000**

- electrical dry type vaporizer
- gas temperature outlet – max. 70°C
- for Ex-Zone II
- connection value – 380 V
- 2-staged regulator unit
- max. operation pressure – 25 bar

**Executions**

- 1 – one regulating group, cabinet  
2 – two regulator groups (operating + reserve), cabinet



FAS No.	Number of vaporizers	Capacity, kg/hour	Power consumption, kW	Connections, DN		Output pressure, mbar	Dimensions, mm	Execution	Weight, kg
				Inlet (liquid phase, bypass/discharge line)	Output (vapour phase)				
20 924	2	200	2×18	25/25/25	50	50...300	2000×500×1600	1	360
20 9246	2	200	two regulation lines	25/25/25		50...300	2000×500×1600	2	380
20 321	2	330	2×24	25/25/25		50...300	2000×500×1600	1	380
20 259	3	450	3×24	15/15/25		50...300	2400×1800×1200	1	390
20 324	4	620	4×24	25		1500	2400×600×1800	1	450
20 328	6	900	6×24	25		1500	4800×600×1800	1	650
20 327	8	1250	8×24	25		1500	3000×2500×2600	1	900

**Super serie LPG vaporizer unit FAS 2000**

- electrical dry type vaporizer
- gas temperature outlet – max. 70°C
- for Ex-Zone II
- connection value – 380 V
- 2-staged regulator unit
- max. operation pressure – 25 bar
- outlet pressure – 50...300 mbar

FAS No.	Type	Capacity, kg/h	FAS No.	Type	Capacity, kg/h
20 9873	FAS 2000-100	100	20 9260	FAS 2000-510	510
20 3259	FAS 2000-170	170	20 9261	FAS 2000-680	680
20 9256	FAS 2000-200	200	20 9262	FAS 2000-850	850
20 9257	FAS 2000-270	270	20 3267	FAS 2000-1020	1020
20 9258	FAS 2000-340	340	20 3260	FAS 2000-1200	1200
20 9259	FAS 2000-440	440	20 3270	FAS 2000-1400	1400

**Vaporizer unit in compact design**

with tank and dry-type vaporizer Type FAS 2000, Ex-Zone 2, connection voltage single-phase alternating current 230 V/50 Hz, 3-phase current 400 V/50 Hz, complete mounted in steel sheet cabinet, piped, tank and cabinet are mounted on a galvanized ground frame, piped, grounded and painted.

**Compact unit consisting of:**

- steel sheet cabinet, painter, with rain protection roof, vents, console h=100 mm
- ball valve in in- and outlet as well as between trap and middle pressure regulator
- strainer with fine mesh filter and safety relief valve in front of dry-type vaporizer
- pressure gauge 0-25 bar with pressure gauge shut-off valve in front of and behind the middle pressure regulator
- dry-type vaporizer Type 2000 (see FAS No. 20333, 20554-20556), for Ex-Zone 2, with 2 pcs. of solenoid valves at vaporizer's inlet, 1 safety relief valve at vaporizer's outlet, control box on vaporizer, wired ready for connection
- trap with emptying of remainders
- middle pressure regulator PN 25 with emergency shut-off valve (SAV) and connection with pressure tap (SBV) and pressure gauge
- LPG storage tank acc. to DIN 4680 (domestic tank), for over ground installation, for storage of LPG, with standard fittings
- ground frame in special execution
- excess flow valve
- by pass line from safety relief valves in vaporizer's cabinet

**Execution:**

- Outlet pressure 0,8 bar. Other setting pressures on request. Various adds-on such as step tread for operation of tank fittings, by-pass line with manual switching suitable for unit configuration are available on your request.

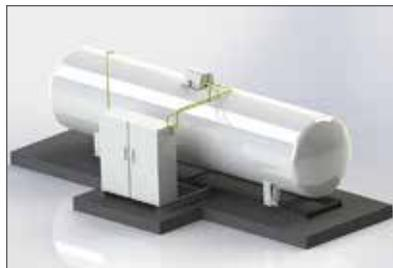
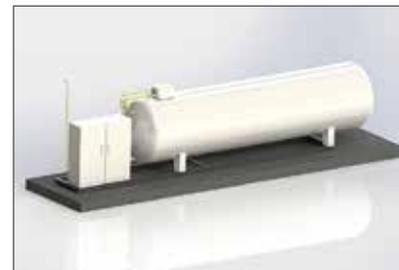

Vaporizer size	Tank size	Ground frame	Cabinet dimensions	Inlet	Outlet	Connection voltage	Connection value eL
15	4850	4230×850×100	1200×800×400	RVS15 left	RVS18 left	230 V	4,4 kW
	6400	5820×850×100					
32	4850	4230×850×100					
	6400	5820×850×100					
60	4850	4230×850×100	1200×1200×400	RVS15 left	RVS22 left	400 V	12,0 kW
	6400	5820×850×100					
100	4850	4230×850×100					
	6400	5820×850×100					





**Vaporizer FAS 3000 are generally designed for middle and large industrial consumers. They will be also used in mixing units for production of liquid gas-air-mixture (synthetic natural gas).**

The effectivity of vaporizers FAS 3000 will be achieved through applications of welded plate heat exchangers especially designed for these purposes with a high efficiency factor as well as their potential to work with small temperature differences. The thermal transfer will be affected over curly plates from stainless steel, mounted in a package. Hot and cold sectors are alternating. Such construction ensures an affective system of heat exchange surface.



*Detailed view of heat exchanger. Special profiling to optimize the heat transfer.*

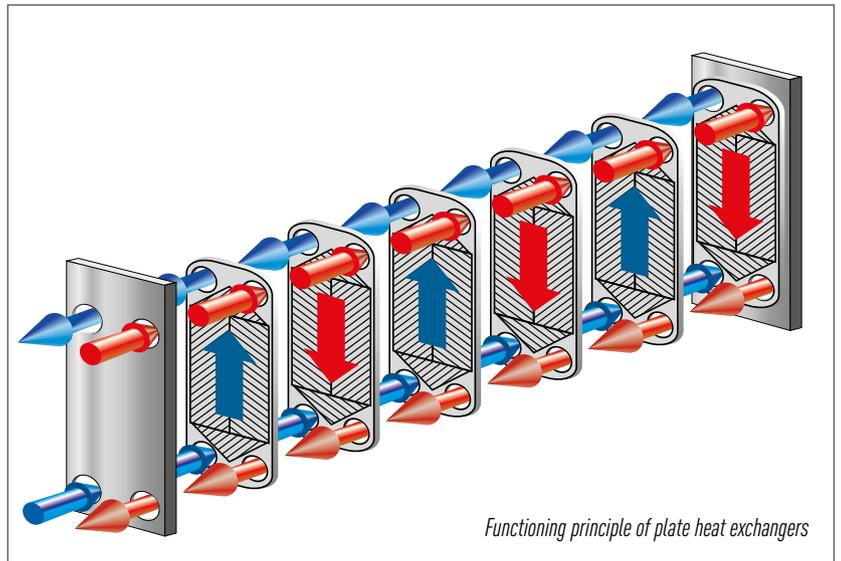

**LPG vaporizer unit FAS 3000**

- capacity – 200 kg/h
- outlet pressure – 50 mbar
- design pressure – 25/10 bar (gas/water)
- heat carrier temperature – 90/70°C
- power supply 230 V
- inlet connection DN 25 (liquid phase, by-pass line, discharge line, hot water)
- outlet connection DN 25/DN 50 (water, gas)
- dimensions – 1200×1200×400 mm
- weight – 255 kg

**Scope of delivery**

- Vaporizer FAS 3000
- Thermostat for gas temperature
- 2 liquid level sensors
- 2 solenoid valves in inlet of liquid phase
- Safety relief valve in liquid phase
- Thermometer
- Pressure switch in water space
- Liquid trap with ball valve for emptying
- Separate control box for mounting outside of Ex-zone
- Regulator unit: (middle pressure regulator, inlet pressure – up to 16 bar,
- Outlet pressure – 1,5 bar, low pressure regulator, outlet pressure – 50 mbar, emergency shut-off valve (SAV) and connection with pressure tap (SBV), pressure gauge

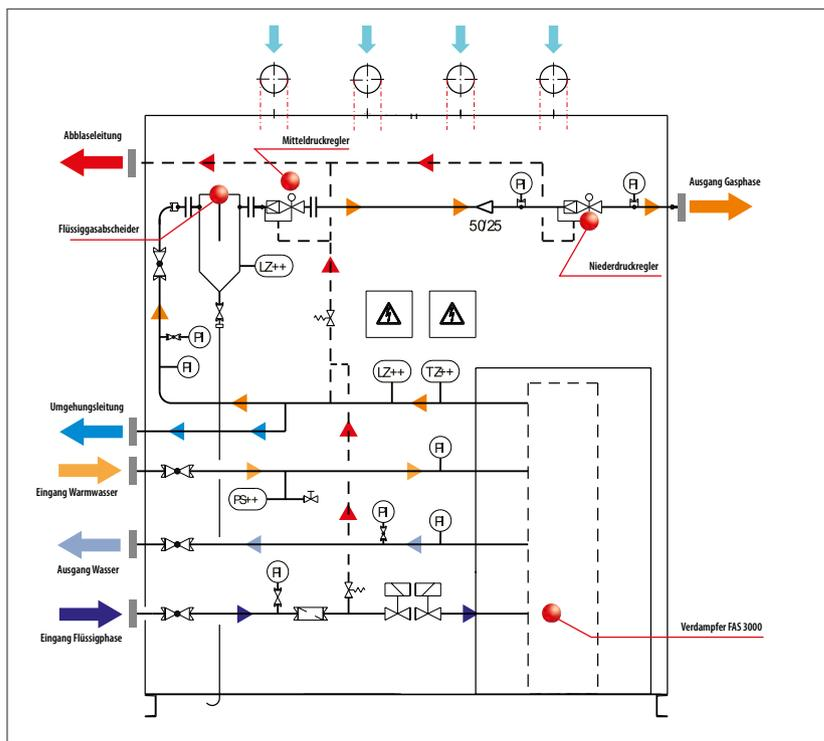

Hydraulic schema of vaporizer unit  
FAS 3000-200

Vaporizer type	Capacity, kg/h
FAS 3000	200
	300



### LPG vaporizer unit FAS 3000

- outlet pressure – 50...5000 mbar,
- design pressure – 25/10 bar (gas/water)
- heat carrier temperature – 90/70°C
- thermostat for gas temperature
- 2 liquid level sensors
- 2 solenoid valves in inlet of liquid phase, safety relief valves in liquid phase
- pressure switch in water space
- liquid trap with ball valve for emptying
- separate control box for mounting outside of Ex-zone
- regulator unit

FAS No.	Capacity, kg/h	Pressure, outlet, mBar
20 247	400-800	without regulator group
20 246	1000-1200	without regulator group
20 245	1500-1900	without regulator group
20 229	up to 4000	without regulator group
20 249	up to 7000	without regulator group
20 250	up to 12000	without regulator group
20 248	400-800	20-2100*
20 2481	400-800	5-5000*
93 065	1000-1200	5-5000*
93 073	1500-1900	5-5000*
93 153	up to 4000	5-5000*
93 074	up to 7000	5-5000*
93 075	up to 14000	5-5000*



### SNG Mixing plants (Propane-Air technology)

usually are used for replacement of natural gas. The use of SNG mixing plants FAS-LT (PROPANE-AIR Technology) allows consumers to completely switch to the use of propane-butane and not depend on the presence of natural gas in the pipeline.

The new generation of mixing plants FAS-LT (PROPANE-AIR Technology) meets the most stringent requirements and expectations of industrial users:

- Wobbe-index control and management
- SIL2 safety monitoring and shutdown
- Reliable mixing cycle
- Capacity from 3 to 60 MW
- Outlet pressure – from 50 mbar to 3 bar SNG (estimated, pending clarification).



FAS-LT mixer unit	Capacity, MW
FAS-LT 5	up to 5
FAS-LT 10	up to 10
FAS-LT 15	up to 15
FAS-LT 20	up to 20
FAS-LT 25	up to 25

FAS-LT mixer unit	Capacity, MW
FAS-LT 30	up to 30
FAS-LT 40	up to 40
FAS-LT 50	up to 50
FAS-LT 60	up to 60

Mixing plants FAS-LT are distinguished by the provision of conditions for safe mixing of gases:

- emergency shutdown in case of any failure of the installation;
- comparison of the oxygen content calculated from the measured flow with the analyzed value and signaling, if necessary, switching in case of a critical deviation;
- SIL 2 Monitoring of the oxygen content in the gas mixture and shutting off the admixture of air in case of violation of the limit value;
- in the event of a main power failure, the valve and control valves close. The same thing happens if the controller fails. The shutdown chain occurs in the same way when limit values are violated that no longer allow the generation of the desired gas mixture, as well as when the device fails;
- the same thing happens when the measuring device fails in the gas mixing line. The sample gas flow for analysis is controlled by the minimum flow switch limit. Sample gas failure also triggers an alarm;
- if the gas analyzer fails, the control valves close;
- if the pressure regulator fails, the slam-shuts close. Gas pipelines are equipped with backflow protection devices.

Mixing Plants are mainly supplied in "placed on a steel frame" design. "Ready to use" container version is available.

Depending on the conditions and desires of the consumer, FAS-LT Mixing Units are supplied in combination with FAS 2000 or FAS 3000 evaporators.



Mixing units can be designed in special configurations depending on conditions of a special object.



FAS No.	Mixing units Type	Capacity, m <sup>3</sup> (propane-air-mixture) kg/h	Inlet/Outlet LPG	Inlet/Outlet pressure, mbar
93 710	FAS 4000-32 ND	30/30	DN 15/DN 50	2000-5000/ up to 500
93 711	FAS 4000-60 ND	50/60	DN 15/DN 50	
93 712	FAS 4000-100 ND	80/100	DN 20/DN 65	
93 713	FAS 4000-160 ND	130/160	DN 25/DN 65	
93 714	FAS 4000-300 ND	240/300	DN 25/DN 65	
93 953	FAS 4000-640-4 ND	640/790	DN 32/DN 200	
-	FAS 4000-1200 ND	1200/1480	DN 65/DN 200	

## SNG mixer/propane air mixer "FAS-LT Combi Manual"

The combined mixing system is built in a steel cabinet and forms a closed combination of LPG vaporizer system and a PROPANE-AIR (SNG) MIXING SYSTEM.

### Operating data:

- Maximum capacity: 1; 2; 4 or 6 MW
- Output pressure: 1.5 barg (adjustable)
- 20...40% air in standard propane (Wobbe below: 11.4...12.3 kWh/m<sup>3</sup>)
- Inlet pressure propane: 6.5 barg
- Compressed air from on-site supply: 4.5 barg
- Liquefied gas inlet: flange DN 25, DN 40 or DN 50
- Air inlet: flange DN 25
- Mixed gas outlet: flange DN 25 or DN 50

The automated control section of the mixing system is set up in a separate field cabinet. It must be installed outside the Ex zone.

### Operation advantages are:

- Manual adjustment via metering valves, with data reading via pressure gauge and two flow meters
- Filter in every gas line
- Check valves in each gas line
- Pneumatic dome pressure regulators to regulate gas inlet pressures
- Differential pressure monitoring between propane and air
- Variable area flow meters for propane and air adapted to flow
- Automated shut-off valve in the air line
- Manual metering valves in each gas line, adapted to the flow rate
- Automated shut-off valve in the mixed gas line
- Possibility to relieve the pressure on the pipe system
- O<sub>2</sub> limit concentration monitoring with O<sub>2</sub> sensor for EXII 2G EX db IIC T4 GB classification (internal and external explosion protection)



- Calibration without external gas connections, possibility of flushing with inert gas
- All cables on terminal box
- Control and evaluation of gas analysis in a separate field housing with 4" touch screen, outside the Ex zone

Unit (combi manual execution)	Capacity, MW	LPG supply, kg/h	V AIR, Nm <sup>3</sup> /h	V SNG MIX, Nm <sup>3</sup> /h
FAS-LT-1-1,5	0,2-1	20-98	3,5-23	66-72
FAS-LT-2-1,5	1-2	98-193	17-45	131-142
FAS-LT-4-1,5	3-4	289-386	52-90	263-284
FAS-LT-6-1,5	5-6	482-577	86-134	393-425

## Turn key solutions for gas supply plants: LPG, SNG applications

Typical applications/users are:

- installations for the BIOGAS production plants (using LPG to increase calorific value),
- industrial consumers of natural gas (complete or partial replacement of natural gas with a mixture of propane-air (SNG))

## Complete project management:

- full support in a plants engineering;
- support in a permission activities;
- engineering support for civil works (land preparation, foundation, power supply, air supply, etc.);
- supply of a complete set of necessary equipment;
- installation and commissioning;
- training of operating staff;
- after-sales service.



Installation of underground tank  
of LPG/SNG gas supply system

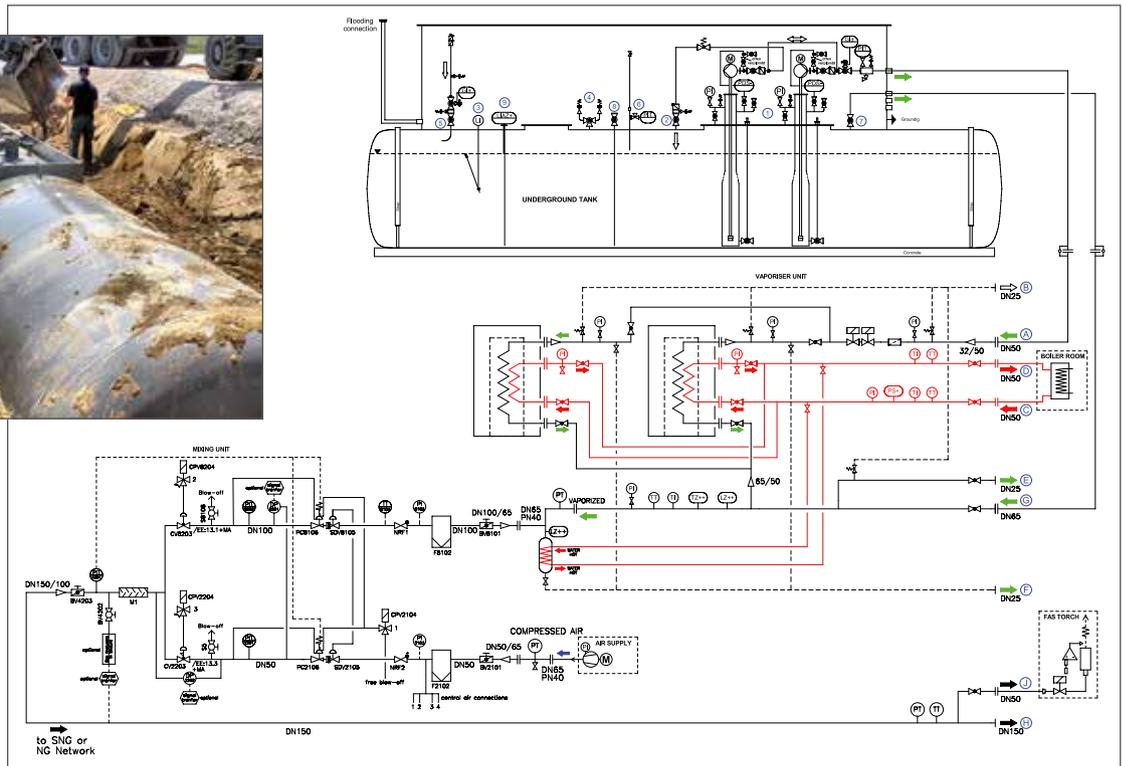

Hydraulic scheme of installation  
of LPG/SNG gas supply system

## F

## Accessories for road tankers

Advantages of LPG  
FAS-NZ pumps

- low noise emission
- low vibration
- high reliability

Recommended pump  
protection elements:

- dry run protection (like FAS 18 382)
- oil pressure switch (like FAS 18 456 or 18 4563)
- by pass valve (like FAS 19 333, 19 337, 19 350)

## Pump FAS-NZ without motor



## Pump units FAS-NZ

with hydraulic motor in truck execution



FAS-No.	Type	Capacity, m <sup>3</sup> /h (l/min)	Differential pressure, bar	NPSH stage	Connection for hydraulic motor
46 0953	STW NZ24-8	24 (400)	9	-	PARKER F11-14
46 0980	STW NZ24-7	24 (400)	8	+	PARKER 11-019
46 0952	STW NZ48-8	48 (800)	9	-	PARKER F11-19
46 0964	STW NZ60-7	60 (1000)	7	-	PARKER F11-19

FAS-No.	Type	Capacity, m <sup>3</sup> /h (l/min)	Differential pressure, bar	NPSH stage	Hydraulic motor type	Liquid demand, l/min, connection
46 0955	STW NZ24-8	24 (400)	9	-	SUNFAB 010	29, G¾"
46 0961	STW NZ24-8	24 (400)	9	+	SUNFAB 012	38, G¾"
46 0954	STW NZ48-8	48 (800)	9	-	SUNFAB 012	38, G¾"
46 0969	STW NZ60-7	60 (1000)	7	-		





FAS-Corken  
pump unit Z 3500

### Pump unit with hydraulic motor PN 25

- for positive suction head
- pump case of ductile iron ASTM A536
- with single-acting mechanical seal
- complete unit consisting of pump
- hydraulic adaptor, coupling and hydraulic motor
- ready for connection mounted, primed and painted

FAS No.	Pump Type	Motor, kW	Capacity, l/min	Speed, RPM	Oil recirculated quantity, l/min	Oil pressure, bar
<b>Pump with NPT-threaded flanges, right-handed, execution A (Corken/Danfoss)</b>						
21 5720	Z 2000/OM 80	5,5	220	640	58,0	100
21 299	Z 3200/OM 100	10,0	450	550	29,0	232
21 2993	Z 3200/OM 80	8,0	400	750	52,0	110
21 2995	Z 3500/OM 100	10,0	450	550	60,0	140

*Pump units left-handed on your request. Power rating at 5 bar differential pressure. Inlet flange 3" ANSI 300 lbs*

<b>Pump with welding ends, right-handed, execution A (Blackmere/Danfoss)</b>						
21 572	LGL 2"E/OM 80	5,0	220	650	58,0	100
21 573	LGL 3"F/OM 100	10,0	380	550	29,0	232
21 574	LGL 3"F/OM 100	10,0	380	550	60,0	140
21 576	LGL 2"E/OM 80	5,0	220	650	58,0	100
21 577	LGL 3"F/OM 100	10,0	380	550	29,0	232
21 578	LGL 3"F/OM 100	10,0	380	550	60,0	140

*Pump units left-handed on your request. Power rating at 5 bar differential pressure.*



without printer



with printer



with TEX-Register

### Complete measuring unit Type LC

- flow direction from left to the right
- BUNA seals
- include fastening base without ground plate
- housing for road tanker: type MA-4 up to MA-15 – from alu
- housing for stationary units: type MSA-15 up to MSA-120 – from steel

**Equipment:** Back check pressure valve in inlet (standard for MA-4 – MA-7), vapor eliminator with fine mesh filter, LC-Meter, mechanical counter Type VR with ticket printer, differential pressure valve. Combination options, spares and conversion parts on special request: electronic counter with ticket printer, flow direction from right to the left, with DIN-flanges, with pulser etc.

FAS No.	Type	Connection	Capacity, l/min	Operation pressure, bar	Housing	Temperature compensation	Weight, kg
---------	------	------------	-----------------	-------------------------	---------	--------------------------	------------

### Execution for road tanker

18 7935	FAS-LC MA 7GX 10	2"	75...380	25	Alu	-	44,0
18 7936	FAS-LC MA 7GX 10	2"	75...380	25		- (without printer)	43,0
98 1657	FAS-LC MA 7 TEX	2"	75...380	25		+ (and Ex-pulser)	46,0
18 794	FAS-LC MA 15 GX 10	3"	150...760	25		-	49,0
98 1642	FAS-LC MA 15 TEX	3"	150...757	25		+	46,0

### MID-TEX measuring unit for LPG road tankers and LPG applications

- flexible configuration
- compact design
- big coloured display
- Coriolis mass flow meter
- data transfer via MODBUS possible
- LPG filling in mass (kg) and/or volume (l)
- density monitoring
- free to configure delivery ticket
- "app" data transfer
- remote control operation, external communication via serial cable, Ethernet, Bluetooth and WiFi
- Ex d-design of TEX register



### FAS 98 1631 TEX Register

could be used in measuring systems for the following liquids:

- petrochemical business: crude oil, liquid hydrocarbons, industrial oil, LPG ect
- liquid food
- alcohol, ethanol ect
- chemical product in liquid forms

- distilled water, deionized water ect
- other liquids not listed

*Please note: TEX-Register could be combined with*

- all coriolis meters with MODBUS communication
- all liquid controls PD meters equipped with pulser

FAS-Nr	Country-design	Version
98 1623	Germany	MID 400
98 1624	France	MID 400
98 1625	Turkey	MID 400
98 1626	Russia	MID 400
98 1627	Ukraine	MID 400
98 1628	Poland	MID 400
98 1629	Czech Republic	MID 400
98 1630	Kazakhstan	MID 400
98 1614	nv	MID800
98 1641	nv	MA7-TEX
98 1642	nv	MA15-TEX

Design for other countries by request available



### Measuring unit MID 400 – ME 4000

with following main components:

- gas separator with filter screen
  - check valve at the inlet
  - LPG mass DN 40
  - pressure relief valve
  - connections 2" NPT
  - printer
  - preset equipment
- flow direction from left to right

### Electronic calculator ME 4000:

- mounted on meter
- basic software
- mounting base for printer
- ambient temp: -25/+55°C
- input voltage: 24 V DC
- ATEX+MID approvals

FAS No.	Description
98 1720	MID 400
98 9303	ME 4000

**FAS Hose Reel with pneumatic drive, Type VIP 40, PN 25**

- road tanker version in ALU – light-weight design,
- for LPG high pressure pipe line DN 32
- hose length max. 40 m
- inlet left-hand DN 40
- outlet right-hand 1½" NPT IG (hose connection)
- regulation: push lever valve
- bracket for road tanker connection 1¾ ACME
- completely mounted and tested for functioning

**Supply options:**

- including the LPG-Hose
- including the measuring
- system LPG-Control MID 400

FAS No.	LPG-hoses Type	Weight, kg
24 3426	DN 32 max. 40 m	41,60

**Hose reels Type Hannay Reels**

with hand crank

- LPG high-pressure hoses LPG 25 / LPG 32
- hose connection – G¼" male
- inlet – 1½" NPT female
- swivel joint 90°
- completely mounted on base frame, primed and painted

**Type:**

- A – inlet and drive right-hand
- B – inlet and drive left-hand

**Hose reels Type Hannay Reels**

with pneumatic drive

- LPG high-pressure hoses LPG 25 / LPG 32
- hose connection – G¼" male
- inlet – 1½" NPT female
- swivel joint 90°
- completely mounted on base frame, primed and painted

**Type:**

- A – inlet and drive right-hand
- B – inlet and drive left-hand



FAS No.		Type of LPG high pressure hoses	Weight, kg
Type A	Type B		
24 331	24 332	LPG 25 (up to 44 m) LPG 32 (up to 38 m)	50,0
24 333	24 334	LPG 25 (up to 60 m) LPG 32 (up to 50 m)	57,0

FAS No.		Type of LPG high pressure hoses	Weight, kg
Type A	Type B		
24 341	24 342	LPG 25/32 (up to 44/38 m)	60,0
24 343	24 344	LPG 25/32 (up to 60/50 m)	68,0

**Hose reels Type Hannay Reels with hydraulic drive**

- hydraulic drive
- LPG high pressure hose LPG 25 and LPG 32
- inlet – 1½" NPT female
- swivel joint 90°
- completely mounted on base frame, primed and painted

**Type:**

- A – inlet and drive right-hand, hose connection G 1¼" male
- B – inlet and drive left-hand, hose connection G 1¼" male
- C – inlet and drive left-hand, hose connection 1¼" NPT male
- D – inlet and drive right-hand, hose connection 1¼" NPT male

FAS No.				Type of LPG high pressure hoses	Weight, kg
Type A	Type B	Type C	Type D		
24 361	24 362	24 365	24 366	LPG 25 (up to 44 m) LPG 32 (up to 38 m)	62,0
24 363	24 364	24 368	24 367	LPG 25 (up to 60 m) LPG 32 (up to 50 m)	68,0

**Tandem hose reels Type Hannay Reels**

- left reel for LPG high-pressure hose LPG 25 for a length up to 40 m, with swivel joint 90°, inlet 1½" female NPT and hose connection 1" female NPT
- right reel for LPG high-pressure hose LPG 13 for a length up to 40 m, with swivel joint 90°, inlet 1" female NPT and hose connection ½" female NPT
- completely mounted on a base frame, primed and painted

**Type:**

- A – with hand drive
- B – with pneumatic drive
- C – with hydraulic drive

FAS No.	Type	Weight, kg
24 356	A	92,0
24 329	B	106,0
24 351	C	110,0

**Complete high-pressure hose line**

suitable for hose reel

- complete with hose connections on both sides
- inlet flat seal with union nut
- outlet – male NPT thread

**Type:**

- A – Length 40 m
- B – Length 50 m

FAS No.		LPG-Hose length	Connection, "		Weight, kg	
Type A	Type B		Inlet	Outlet	Type A	Type B
24 005	24 014	25	G 1¼"	1 NPT	42,0	52,0
24 006	24 015	32		1¼ NPT		

**3-way ball valve PN 63**

- truck version
- from stainless steel
- welding ends
- housing and shaft from 1.4401
- temperature – -30 up to +180°C



FAS No.	Size, DN, "	Weight, kg	Length, mm
19 2311	DN 15, ½"	0,60	75
19 2321	DN 20, ¾"	0,90	80
19 2330	DN 25, 1"	1,40	90
19 2350	DN 40, 1½"	2,90	125

FAS No.	Size, DN, "	Weight, kg	Length, mm
19 2360	DN 50, 2"	4,70	150
19 2370	DN 65, 2½"	10,30	185
19 2380	DN 80, 3"	15,30	205
19 2390	DN 100, 4"	24,60	240

**Cable drum type FAS**

- cable and earthing clamp
- spring rewind, lockable in any position
- cable material – copper cable cross section 2,5 mm<sup>2</sup>

FAS No.	Type	Cable length, m	Weight, kg
24 321	open execution	50	17,6
24 322	open execution	25	7,0
24 019	closed execution	30	7,0

**Quick-acting shut-off valve PN 25**

- angular
- material – steel
- open position with locking device
- outlet with vent valve

FAS No.	Type RegO	Execution	Inlet/outlet	Weight, kg
13 021	A7708 L	angle form	1" NPT / 1" NPT	1,6
13 022	A7707 L	straight form		1,7

**Quick-acting shut-off valve PN 25**

- with safety filling device

FAS No.	Type	Inlet/outlet	Lock	Weight, kg
13 018	RegO/FAS	1" NPT IG / 1 3/4" ACME	+	2,9
13 031	RegO/FAS		-	2,9

**Quick-acting valve PN 25**

- material – steel
- with safety filling device
- closing position with lock
- suitable for LPG and ammonia

FAS No.	Type RegO	Execution	Inlet/outlet	Weight, kg
13 0351	A7793 A	angle form	3/4" NPT / 1 3/4" ACME	2,9
13 035	A7797 A	angle form	1" NPT / 1 3/4" ACME	2,8

**Excess flow valve PN 25 for road tankers**

- of stainless steel 1.4541
- 2" female NPT connection on both sides
- for installation in front of hose reel



FAS No.	Type	Capacity (liquid phase), U/min	Weight, kg
24 013	FAS 697-2	1210	2,5



### Wheel block as rolling protection

for road tankers up to 40 tons gross weight

- stainless steel
- mechanical switch EEx dII C T6, 250 V AC/6 A respectively 24 V DC/4 A Ex-proof
- cable connecting end length = 10 m
- flexible plastic protection hose

FAS No.	Execution
24 191	In case of interruption of contact, e.g. in case of rolling of the tank truck, the stop of the filling process is effected by the quick-acting shut-off equipment, respectively by the emergency stop system

### Pneumatic actuator for RegO internal valves

FAS No.	Type RegO	Connection, "
24 137	A3209 PA	1 1/4
24 138	A3212 PA	2
24 139	A3213 PA	3

### Hand pump

for RegO internal valves with hydraulic control

FAS No.	Execution	Weight, kg
24 751	Type Whessoe 7012, connection – 1/4" BSP, with oil tank, max. oil pressure 80 bar	15,0

### Line housing

for pneumatic internal quick-acting valves type Whessoe

- for installation in pipelines
- steel body with reinforced bolts
- flange connection according to ASME/ASA, Class 300

FAS No.	Connection, "	Max. pressure, bar	Weight, kg
24 731	2	30	20,0
24 732	3		31,0
24 733	4		50,0
24 734	6		73,0
24 735	8		103,0
24 736	10		127,0

### Internal valve flanged

- housing from ASTM A395 or similar
- with integrated excess flow valve
- hand lever mechanical switching with cable, pneumatic or hydraulic actuator possible



FAS No.	Type RegO	Closing volume, GPM / l	Connection (flange 300 lb)	Weight, kg
28 107	A3217 AR410	410/1550	3"	20,0
28 1079	A3217 AR510	510/1930	3"	17,8
28 308*	A3217 DAR410	410/1550	3"	29,4
28 0881	A3219 FA400L	400/1515	4"	31,0
28 088	A3219 FA600L	600/2270	4"	30,0

\* Version with double flange connection. Other flow rates on request



### Internal valve PN 25, type RegO Flomatic

- automatically operated
- with visual indicator for "open" and "closed" position
- with double flange connection

FAS No.	Type RegO	Connection (flange 300 lb)	Weight, kg
24 141	A7883FK	3"	24,0
24 142	A7884FK	4"	33,0

**Internal valve with NPT connection**

- body of ductile iron ASTM A395 or equivalent
- with built-in excess flow valve
- hand lever
- actuated mechanically by cable, by pneumatic or by hydraulic force

RegO internal valve with ANSI-flange on request



FAS No.	Type	Connection NPT, "	Outlet	Weight, kg	Pic.
24 131	RegO A3209 A050	1¼	1	0,9	1
24 132	RegO A3212 A175	2	1	4,1	2
24 135	RegO A3213 A300	3	1	7,3	3
24 101	Fisher C407-10	1¼	1	0,9	1
24 1021	Fisher C427-16	2	1	4,1	2

FAS No.	Type	Connection NPT, "	Outlet	Weight, kg	Pic.
24 103	Fisher C421-16	2	2	5,0	2
24 104	Fisher C402-16	2	3	6,8	2
24 1051	Fisher C427-24	3	1	7,3	3
24 106	Fisher C421-24	3	2	9,6	3
24 107	Fisher C402-24	3	3	17,2	3

**Internal withdrawal-quick acting valve (type Whessoe)**

- additional body for pipe lines
- automatically close
- with hydraulic or pneumatic control system (min. 5 bar)
- body of ASTM A352 Grade LCB, chromed steel cylinder and pistons, spring of stainless steel
- connection auxiliary energy ¾" NPT

**Type:**

- A – type 6239, for pneumatic control, flange connection to DIN 2635, with approval according to EEC directive 94/55/CE, not available, only spare parts
- B – type 6239, for pneumatic control, flange connection according to ANSI/ASA RF, not available, only spare parts
- C – type 6139, from 8" type 6240, for hydraulic control, flange connection according to ANSI/ASA RF

FAS No.		Max. pressure, bar	Connection ANSI/ASA RF, "	Weight, kg
Type B	Type C			
–	24 721	21,0	2	9,0
–	24 722		3	12,0
–	24 723		4	21,0
–	24 724	17,5	6	32,0
–	24 725		8	47,0
–	24 726		10	63,0

FAS No.	For internal valve Type A, B	FAS No.	For internal valve Type C
24 791	6239 – 2" / DN 50	24 742	6139 – 3"
24 792	6239 – 3" / DN 80	24 743	6139 – 4"
24 793	6239 – 4" / DN 100	24 744	6139 – 6"
24 794	6239 – 6" / DN 150	24 745	6139 – 8"
	<b>Type C</b>	24 746	6139 – 10"
24 741	6139 – 2"		

## G

## Shut-off, bypass, 3-way, solenoid, ball, quick-acting valves

## Globe valve

- NPT-thread
- soft seal



FAS No.	Type	Size, DN, "	Length, mm	Weight, kg
19 001	N301-04	1/2	94	1,40
19 002	A7505 AP	3/4	94	1,10
19 003	A7507 AP	1	110	1,60
19 004	A7509BP	1 1/4	125	3,10
19 005	A7511AP	2	150	3,70
19 006	A7513AP	2	150	7,70
19 007	A7517AP	3	230	18,00

## Angle valve

- NPT-thread
- soft seal



FAS No.	Type	Size, DN, "	Length, mm	Weight, kg
19 009	N401-04	1/2	45	1,25
19 010	A7506 AP	3/4	45	1,20
19 011	A7508AP	1	51	1,20
19 012	A7510 BP	1 1/4	57	2,70
19 013	A7512AP	1 1/2	62	3,60
19 014	A7514 AP	2	69	5,00
19 015	A7518AP	3	102	15,00

## Ball valve with spring release

- NPT-thread
- mechanical hand lever



FAS No.	Type	Size, DN, "	Length, mm	Weight, kg
19 151	Argus	1/2	90	2,0



**Shut-off valve**

- NPT-thread
- collar seal

**Type**

- A – straight type
- B – angle type



FAS No.	Type	Size, DN, "	Length, mm	Weight, kg	Pic.
Type A					
19 017	7704 P	1/2	95	1,0	1
19 018	7705 P	3/4	95	1,0	1
Type B					
19 020	7704 LP	1/2	43	0,9	2
19 021	7706 P	3/4	43	0,9	2

**Quick acting valve with lever**

- NPT-thread



FAS No.	Type	Size, DN, "	Length, mm	Weight, kg	Pic.
19 026	7901 T	1/4	63	0,6	1
19 027	7554 SAV	1/2	94	1,0	2
19 028	7554 SV	3/4	94	1,0	2

**Shut-off valve/  
regulating valve PN 20**

- NPT-thread



FAS No.	Type	Size, DN, "	Weight, kg	Pic.
19 033	1224 WA	1/4	0,1	1
19 034	2553	1/4	0,7	2
19 035	2553 A	3/8	0,7	2

**Ball valve type F120 PN 63**

- full bore
- two-piece body – steel 1.4408
- seals of PTFE
- ball of stainless steel CF8M
- operating lever
- length acc. to DIN 3202 T4M3



FAS No.	Size, DN	Connection (NPT), "	Weight, kg	FAS No.	Size, DN	Connection (NPT), "	Weight, kg
19 449	8	1/4	0,2	19 453	25	1	0,9
19 450	10	3/8	0,3	19 454	32	1 1/4	1,5
19 451	15	1/2	0,4	19 455	40	1 1/2	2,2
19 452	20	3/4	0,6	19 456	50	2	2,9

**Angle valve**

- connection 3/4" NPT male

Other dip tubes are available on request



FAS No.	Type	Outlet	Material	Pic.	Weight, kg
19 439	9101 C1	POL	Brass	1	0,4
19 440	7550 P	3/4" NPT	Brass	1	0,6
19 441	FAS 484	3/4" NPT, with brass plug	Brass	1	0,7
19 442	A7550 P	3/4" NPT	Steel	1	0,6
19 443	7550 PX	3/4" NPT, with excess flow valve	Brass	2	0,6
19 444	A7550 PX	3/4" NPT, with excess flow valve	Steel	2	0,6
19 445	901 C5	POL, with excess flow valve	Brass	2	0,4
19 446	9101 DNP	POL, with dip tube 300 mm	Brass	-	0,5
19 447	FAS 483	POL, with dip tube 300 mm and pressure gauge	Brass	3	0,7
19 448	Brass plug for angle valve 3/4" NPT, brass, with seal				

**Ball valve  
straight type with hand  
lever**

- execution „Fire-Safe“ acc. to BS 6755 part 2,
- compact FAS-KHV
- body and ball of stainless steel (CrNi AISI 304), seals – PTFE
- leakproof class 1 acc. to DIN 3230 part 3



FAS No.	Size, DN	Weight, kg	Length, mm
93251	15	1,5	38
93252	20	2,0	40
93253	25	2,7	45
93254	32	5,2	58
93255	40	6,8	64
93256	50	11,1	82
93257	65	15,6	103
93258	80	22,3	122
93259	100	37,3	150

**Shut-off valve**

- straight type
- flanges acc. to DIN 2635
- length acc. to DIN 3202
- body of cast steel GS-C 25
- seat ring, disc and stem of stainless steel
- leakproof class 1 to DIN 3230 part 3

**Type:**

- A – gland seal of pure graphite
- B – bellows seal, maintenance free



FAS No.		Size, DN	Length, mm	Weight, kg
Type A	Type B			
19 041	19 101	15	130	4,8
19 042	19 102	20	150	5,4
19 043	19 103	25	160	7,1
19 044	19 104	32	180	8,0
19 045	19 105	40	200	11,5
19 046	19 106	50	230	13,5
19 047	19 107	65	290	23,5
19 048	19 108	80	310	28,0
19 049	19 109	100	350	39,5

**Ball valve**

full bore with operating lever

- execution "Fire-Safe" acc. to BS 6735 part 2
- body – ASTM A 105
- ball – of stainless steel (CrNiAlSI 304)
- seals – of PTFE
- leakproof class 1 acc. to DIN 3230

**Type:**

- A-type FAS-KHB, compact execution, block body
- B-type FAS-KHF, standard, two piece body



FAS-KHB



FAS-KHF

FAS No.		Size, DN	Weight, kg	
Type A	Type B		Type A	Type B
92 151	92 271	15	1,3	3,3
92 152	92 272	20	1,9	4,5
92 153	92 273	25	2,6	6,0
92 154	92 274	32	5,3	8,0
92 155	92 275	40	6,9	13,0
92 156	92 276	50	11,0	17,0
92 157	92 277	65	15,6	23,0
92 158	92 278	80	22,4	28,0
92 159	92 279	100	37,4	43,0
92 171	92 280	125	60,0	69,0
92 172	92 281	150	-	80,0
92 173	92 282	200	-	120,0

**Ball valve PN 40 type Mecafrance**

- three-piece body of forged steel C 22.8
- seals of PTFE, selector shaft and ball of stainless steel
- operating lever

**Type:**

- A – full bore
- B – reduced bore, standard execution
- C – seal kit

*Special executions: for road tankers, FIRE SAFE, and for temperature up to -20°C are available on request.*



FAS No.				Size, DN, "	Weight, kg	FAS No.	Size, DN, "		Weight, kg
Welding ends		Pipe thread	NPT-thread			Type C	full bore	reduced bore	
Type A	Type B	Type B	Type B						
19 121	19 231	19 241	19 251	15 – ½	0,5	19 261	10 – ¼	15 – ½	0,1
19 122	19 232	19 242	19 252	20 – ¾	0,8	19 262	15 – ½	20 – ¾	0,1
19 123	19 233	19 243	19 253	25 – 1	1,3	19 263	20 – ¾	25 – 1	0,1
19 124	19 234	19 244	19 254	32 – 1¼	1,8	19 264	25 – 1	32 – 1¼	0,1
19 125	19 235	19 245	19 255	40 – 1½	2,8	19 265	32 – 1¼	40 – 1½	0,1
19 126	19 236	19 246	19 256	50 – 2½	3,8	19 266	40 – 1½	50 – 2	0,1
19 127	19 237	-	-	65 – 2	7,5	19 267	50 – 2	65 – 2½	0,1
19 128	19 238	-	-	80 – 3	12,0	19 268	65 – 2½	80 – 3	0,1
19 129	19 239	-	-	100 – 4	20,5	19 269	80 – 3	100 – 4	0,1

**Stainless steel ball valves  
PN 63**

- truck version
- from stainless steel
- welding ends
- housing and shaft from 1.4401
- working temperature –  
-30 up to +180°C

FAS No.	Size, DN, "	Weight, kg	Length, mm
19 2311	DN 15, ½"	0,60	75
19 2321	DN 20, ¾"	0,90	80
19 2330	DN 25, 1"	1,40	90
19 2350	DN 40, 1½"	2,90	125
19 2360	DN 50, 2"	4,70	150
19 2370	DN 65, 2½"	10,30	185
19 2380	DN 80, 3"	15,30	205
19 2390	DN 100, 4"	24,60	240



**Ball valve PN 40**

with full bore with electrical actuator

- "Fire-Safe" version acc. to BS6755 part 2
- type with flanges – Type FAS-KHF
- type compact – Type FAS-KHB
- body – of steel ASTM A105
- ball – of stainless steel (CrNi AISI 304)
- seals – of PTFE
- leakproof class 1 acc. to DIN 3230
- electrical actuator – AUMA NORM SGEXC

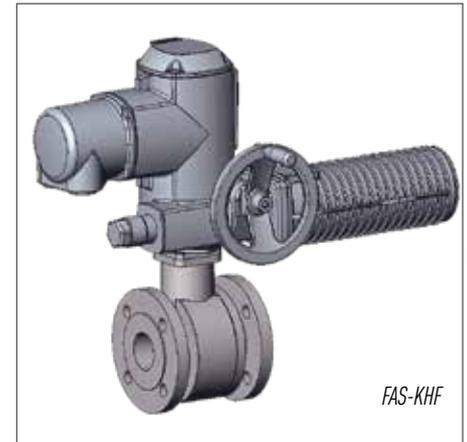

FAS No.	Size, DN	Weight, kg
93820	15	26,5
93821	20	27
93822	25	28
93823	32	31
93824	40	32

FAS No.	Size, DN	Weight, kg
93825	50	36
93826	65	41
93827	80	48
93828	100	51
93829	125	94

FAS No.	Size, DN	Weight, kg
93830	150	121
93831	200	240
93832*	250	500

\*with FAS-KHF

**Electrical actuator AUMA series SGEXC for ball valve**

- bending range – 80...110°
- Ex-protection – IIG EEx de IICT4
- temperature range – -40...+40°C
- power supply – 400 V 50 Hz, protection class IP 67

FAS No.	Ball valve size	Actuator type
93844	DN 15, DN 20, DN 25, DN 32, DN 40, DN 50, DN 65	SGExC 05.1
93845	DN 80, DN 100, DN 125	SGExC 07.1
93847	DN 150	SGExC 12.1



**3-way ball valve type FAS-KHF W3, PN 40**

- full bore
- body – of steel ASTM A105, ball – of stainless steel CrNi AISI 304, seals – of PTFE
- L-bore
- flanges acc. to DIN 2635
- three-piece body
- hand lever



FAS No.	Size, DN	Weight, kg	FAS No.	Size, DN	Weight, kg
92 292	DN15	4	92 297	DN65	34
92 291	DN20	6	92 298	DN80	50
92 293	DN25	7	92 299	DN100	71
92 294	DN32	12	92 300	DN125	119
92 295	DN40	14	92 301	DN150	185
92 296	DN50	20			

**Quick-acting ball valve PN 40**

with full bore

- "Fire Safe" version acc. to BS6755 part 2 and antistatic device
- flanges acc. to DIN 2635
- seals – of PTFE
- leakproof class 1 acc. to DIN 3230
- with pneumatic actuator in maintenance free compact execution, angle of rotation 90°, with automatic spring return, 5-8 bar, min. pilot pressure of 5 bar (at a max. differential pressure of 25 bar)

**Type:**

- A – type ARGUS, body of forged steel TSTE 355N, ball and shaft of stainless steel, shaft seal of Viton
- B – type ALFA, body of forged steel ASTM A 105 (C 21), ball and shaft of stainless steel, shaft seal of PTFE/Viton
- C – type Bont, body of forged steel ASTM A 105 (C 21), three-piece body, ball and shaft of stainless steel, shaft seal of PTFE/Viton



**Quick-acting ball valve**

- DIN-flange connection on both sides
- length acc. to DIN 3202
- F4/F5 short model

FAS No.		Size, DN	Length, mm	Weight, kg	
Type A	Type B			Type A	Type B
19 700	19 730	15	115	8,0	8,5
19 701	19 731	20	120	9,0	9,5
19 702	19 732	25	125	9,5	10,5
19 703	19 733	32	130	14,2	15,3
19 704	19 734	40	140	15,1	18,8
19 705	19 735	50	150	21,4	26,4
19 706	19 736	65	170	33,5	37,7
19 707	19 737	80	180	47,0	53,0
19 708	19 738	100	190	69,3	80,0
19 709	19 739	125	325	80,0	95,0
19 880	19 890	150	350	137,0	122,0

**Quick-acting ball valve**

- Welded end connection on one side
- DIN-flange on other side

FAS No.		Size, DN	Length, mm	Weight, kg		
Type A	Type B			Type A	Type B	Type C
19 750	19 860	15	230	7,6	205	7,5
19 751	19 861	20	250	8,3	225	8,1
19 752	19 862	25	260	9,5	235	9,3
19 753	19 863	32	250	13,0	250	12,4
19 754	19 864	40	260	14,9	270	14,6
19 755	19 865	50	270	20,2	211	25,5
19 756	19 866	65	285	32,4	250	34,5
19 757	19 867	80	315	46,7	308	48,0
19 758	-	100	355	69,2	-	-
19 759	-	125	463	95,0	-	-

**Accessories**

FAS No.	Type	Weight, kg
19 710	Limit switch in housing, Ex-proof, for open/closed position indication, with optical position indicator	1,8
19 711 19 763 ATEX	½-way solenoid valve, Ex-proof, Namur interface, for compressed air, max. 10 bar, thread connection G¼", operating voltage 230 V, 50 Hz	1,5
19 712	½-way solenoid valve, Ex-proof, for compressed air, max. 10 bar, thread connection G¼", operating voltage 24 V, coflow	1,5



**Solenoid valve PN 40**

- Ex-proof
- with automatic lifting, normal closed
- leakproof class 1 to DIN 3230
- operating pressure – 0...25 bar
- flanges acc. to DIN 2635

**Type:**

- A – body of cast steel
- B – body of stainless steel, non-ferrous free
- C – body of cast steel, non-ferrous free

*Solenoid valves with optical position indicator are available on request.*



FAS No.						Size, DN	Length, mm	Pic.	Weight, kg
Type A		Type B		Type C					
230 B (AC)	24 B (DC)	230 B (AC)	24 B (DC)	230 B (AC)	24 B (DC)				
19 419	19 369	19 429	19 379	-	-	15	130	1	5,5
19 420	19 370	19 430	19 380	-	-	20	150	1	5,8
19 421	19 371	19 431	19 381	-	-	25	160	1	6,5
19 422	19 372	19 432	19 382	-	-	32	180	1	11,0
19 423	19 373	19 433	19 383	-	-	40	200	1	12,0
19 424	19 374	19 434	19 384	-	-	50	230	1	14,0
19 425	19 375	-	-	19 435	19 385	65	290	2	36,5
19 426	19 376	-	-	19 436	19 386	80	310	2	46,5
19 427	19 377	-	-	19 437	19 387	100	350	2	70,0

**Accessories**

19 388	<i>Extra charge for 2 solenoid switches for contactless electronic indication of position ON/OFF for solenoid valves with flanged DN 15-50, Ex-proof to EEx d IIC T6</i>
19 389	<i>Extra charge for 2 solenoid switches for contactless electronic indication of position ON/OFF for solenoid valves with flanged DN 65-100, Ex-proof to EEx d IIC T6</i>



**Solenoid valve PN 40**

- Ex-proof
- indirectly actuated, normal closed
- power supply 230 V, 50 Hz
- operating pressure – 0,5...40,0 bar
- body of brass



FAS No.	Connection female, ”	Length, mm	Weight, kg
19 401	G 1/2	67	0,8
19 402	G 3/4	80	1,2
19 403	G 1	95	1,6
19 404	G 1 1/4	132	2,5
19 405	G 1 1/2	132	3,5
19 406	G 2	160	4,5
19 408	Special voltage 24 V – DC		

**Solenoid valve PN 25**

- Ex-proof
- with automatic lifting, normal closed
- power supply 230 V, 50 Hz
- operating pressure – 0,5...25,0 bar
- body of brass



FAS No.	Connection female, ”	Length, mm	Weight, kg
19 411	G 1/2	67	1,8
19 412	G 3/4	95	4,0
19 413	G 1	95	3,8
19 414	G 1 1/4	132	5,3
19 415	G 1 1/2	132	5,5
19 416	G 2	160	6,6
19 408	Special voltage 24 V – DC		

**By-pass valve PN 25**

- Angle form
- With spring loading
- NPT female thread



FAS No.	Type (Corken)	Connection NPT, ”	Setting ranges, bar	Capacity max. l/min	Weight, kg	Pic.
19 330	B 166	3/4	3,5...10,5	115	3,5	1
19 331	B 166	1	3,5...10,5	150	3,5	1
19 332	B 166	1	1,7...4,1	150	3,4	1
19 333	B 166	1	6,9...15,5	150	3,5	1
19 337	B 177	1 1/2	5,0...11,0	380	3,0	
19 338	B 166	3/4	1,7...4,1	115	3,4	1
19 339	B 166	3/4	6,9...15,5	115	3,6	1
19 346	T 166	1 1/2	6,9...15,5	380	3,5	1
19 348	T 166	1 1/4	6,9...15,5	300	3,8	1
19 349	T 166	1 1/2	3,5...10,5	380	4,0	1
19 350	B 177	2	3,5...8,6	1140	18,8	2
19 354	T 166	1 1/4	3,5...10,5	300	3,8	1
19 355	B 177	1 1/2	4,1...6,9	570	6,0	2
19 359	B 177	1 1/4	5,0...11,0	470	3,8	2

**Safety by-pass valve PN 25**

- gas tight housing
- spring loaded
- flanges acc. to DIN 2635/EN 1092-1
- material – cast steel, internal parts – Niro

**Execution:**

- with boot, independent of back pressure

Order-No.	Size, DN	Length, mm	Height, mm	Weight, kg
19 882	20	150	275	8,5
19 883	25	160	275	10,0
19 884	32	180	275	12,0
19 885	40	200	275	14,0
19 886	50	230	360	25,0
19 887	65	290	360	33,0
19 888	80	310	495	50,0
19 319	<i>Conversion to spring with other adjustment range acc. to table</i>			

*When ordering please specify setting range. Adjustment ranges using different springs in bar:  
1,6 – 2,5    2,5 – 4,0    4,0 – 6,3    6,3 – 10,0    10,0 – 16,0    16,0 – 25,0*

**By-pass valve PN 25**

- housing gas tight, spring loaded
- dependent on back pressure
- with NPT-thread
- housing of ASTM A 536 / ductile iron
- angle form

Order-No.	Blackmer type	Connection, NPT	Adjustment range, bar	Capacity, l/min	Weight, kg
19 321	BV 3/4	3/4"	4,5-7,0	190	2,2
19 322	BV 1	1"	4,5-7,0	190	2,3
19 323	BV 1 1/4	1 1/4"	4,5-8,6	380	3,5
19 324	BV 1 1/4	1 1/4"	7,0-10,5	380	3,5
19 325	BV 1 1/2	1 1/2"	4,5-8,6	380	3,3
19 326	BV 1 1/2	1 1/2"	7,0-10,5	380	3,3
19 327	BV 2	2"	4,5-8,6	600	7,6
19 334	<i>Conversion to spring with other adjustment range acc. to table</i>				

**Liquid withdrawal valve PN 25**

with excess flow valve

**Type:**

- A – Standard model
- B – with built-in back pressure check valve



FAS No.	Type	Inlet, "	Outlet, "	Filling connection	Weight, kg
19 341	A8017 DP	1 1/4 NPT male	1 NPT female	-	1,8
19 342	A8017 DH	1 1/4 NPT male	1 NPT female	with back pressure check valve	1,8
19 343	A8018 DP	1 1/4 NPT male	1 NPT female	1 3/4 ACME male	1,9
19 344	A8016 DP	1 1/4 NPT male	-	1 3/4 ACME male	1,4

**Multivalve PN 25** for storage tanks, body of brass**Components**

- filler valve 1 3/4" ACME
- vapor equalizing valve 1 1/4" ACME
- vapour withdrawal valve POL-female
- vent valve with dip tube
- connection for pressure gauge, flange connection for liquid level gauge, pressure relief valve
- connection for dip tube 3/4" NPT



FAS No.	Type (RegO)	Connection, "	Weight, kg
19 561	8475RV	2 1/2 NPT-IG	5,7
19562	8593 AR 16.0	1 1/2 NPT-AG	1,8

**Duoport pressure relief valve manifold PN 25**

- connection – 2" NPT male
- body – of ductile iron ASTM A395
- for 2 external relief valves 1 1/4" NPT male Type RegO 3135 of brass
- without plastic cap

FAS No.	Type RegO	Connection, "	Relief valve (quantity)	Set pressure, bar	Weight, kg
19 571	A8540	2 NPT male	-	-	4,5
19 572	8542G	2 NPT male	2	17,2	6,8

**Multiport pressure relief valve manifold PN 25**

- ANSI/ASA flanges
- body of ductile iron ASTM A395
- for external relief valves 2 1/2" NPT male type RegO A3149 of steel
- with plastic cap

**Type:**

- A – tank connection 3" ANSI/ASA-flange 300 lbs
- B – tank connection 4" ANSI/ASA-flange 300 lbs



FAS No.	Type RegO	Relief valve (quantity)	Set pressure, bar	Weight, kg
---------	-----------	-------------------------	-------------------	------------

**Type A**

19 511	A8563	no safety relief valve	-	32,0
19 569	8530	2	17,2	30,0
19 512	A8563	3	17,2	53,0
19 513	A8564	4	17,2	60,0
19 570	A8532	2	2...21	40,0
19 514	A8563	3	2...21	53,0
19 515	A8564	4	2...21	60,0

**Type B**

19 516	A8573	no safety relief valve	-	38,0
19 517	A8573	3	17,2	59,0
19 518	A8574	4	17,2	66,0
19 519	A8573	3	2...21	59,0
19 520	A8574	4	2...21	66,0

H

# Pressure regulators • Safety shut off valves



## Medium pressure regulator PN 25

- with 1/4" NPT lateral connection for pressure gauge
- admission pressure – up to 16 bar



## Medium pressure regulator PN 25

- with 1/4" NPT lateral connection for pressure gauge (suitable for liquid or vapor service)
- admission pressure – up to 16 bar
- capacity – up to 80 kg/h



## Medium pressure regulator PN 16

- with 1/8" NPT IG lateral connection for pressure gauge
- admission pressure – up to 16 bar

FAS No.	Type (RegO)	Back pressure, bar	Connection NPT, "	Capacity up to	Weight, kg	
16 001	1584VL	0,4...3,5	1/2	80 kg/h	0,9	
16 002	AA1584VL		1/2	45 m <sup>3</sup> /h (NH <sub>3</sub> )	0,7	
16 003	1586VL		3/4	160 kg/h	1,4	
16 004	AA1586VL		3/4	70 m <sup>3</sup> /h (NH <sub>3</sub> )	1,4	
16 005	1588VL		1	160 kg/h	1,3	
16 007	1584VH		0,4...8,5	1/2	80 kg/h	0,9
16 008	1588VH			1	160 kg/h	1,3

FAS No.	Connection		Weight, kg
	Inlet	Outlet	
16 023	POL	G 3/8 male	0,70
16 024	POL	Ring 12 mm	0,60
16 025	POL	Ring 15 mm	0,63

FAS No.	Fisher Type	Connection NPT, "	Back pressure, bar	Weight, kg
16 011	627-7710	1	0,3...2,5	2,2
16 012	630-104/78	2	2,0...4,0	15,8



## Medium pressure regulator PN 25

- admission pressure – up to 16 bar
- back pressure – 1,5...2,0 bar
- capacity – up to 24 kg/h

FAS No.	RegO Type	Connection NPT, " (inlet/outlet)	Back pressure, bar	Capacity, kg/h	Weight, kg
28 876	LV 3403 TR	1/4 / 1/2	0,7	32	1,30
29 058	LV 3403 VR	1/4 / 1/2	1,5	45	0,57



## Medium pressure regulator PN 25

- with lateral connection for vent line

FAS No.	Type Fisher	Connection NPT, "	Back pressure, bar	Capacity, kg/h	Weight, kg
16 015	627-7710	1	0,4...1,4	230	2,2
16 016	630-104/78	2	0,6...1,4	300	15,8



### Low pressure regulator PN 25

- compact two-stage regulator
- with integral relief valve
- connection for pressure tap 3/4" NPT or 1/4" NPT
- admission pressure – up to 16 bar



### Low pressure regulator PN 2,5

- admission pressure:  
up to 2,5 bar
- back pressure:  
up to 50 mbar (on request)

*Further regulators are available on request*

FAS No.	Type	Connection NPT, "		Back pressure, mbar	Capacity, kg/h	Weight, kg
		Inlet	Outlet			
16 021	RegO LV404H420	1/4	1/2	25...50	11	1,6
16 022	RegO LV404B46H20	1/4	3/4	25...50		1,6
28 000	RegO LV404B46	1/4	3/4	22,8...33		1,6

FAS No.	Type RegO	Connection NPT, "		Capacity, kg/h	Weight, kg
		Inlet	Outlet		
16 013	LV 5503 H620	3/4	3/4	25	1,30
16 014	LV 5503 B4H20	1/2	3/4	25	1,30
16 017	LV 4403 H4620	1/2	3/4	20	1,30
16 018	LV 4403 H420	1/2	1/2	12	1,30
28 300	LV 4403 H414	1/2	1/2	14	1,40



### Low pressure regulator, PN 2,5

- with integral relief valve
- connection for pressure tap 3/4" NPT
- admission pressure – up to 1,7 bar
- back pressure – 35...70 mbar
- capacity – up to 45 kg/h

### Low pressure regulator, PN 2,5

- with integral relief valve
- connection for pressure tap 3/4" NPT
- admission pressure – up to 1,0 bar
- back pressure – 35-70 mbar
- capacity – up to 150 kg/h



### Low pressure regulator, PN 2,5

- with integral relief valve
- connection for pressure tap 1" NPT
- admission pressure – up to 0,9...1,7 bar
- back pressure – 30-70 mbar

FAS No.	Type (Fisher)	Connection NPT, "	Weight, kg
16 041	S102 L-BFC	3/4	2,27
16 042	S102 L-CFC	1	2,27
16 043	S102 L-FFC	1 1/4	2,27
16 044	S102 L-KFC	1 1/2	2,27
16 047	S302 G-FMJ	1/4	3,80
16 048	S302 G-SMJ	2	4,17

FAS No.	Type (Fisher)	Connection NPT, "	Capacity, kg/h	Weight, kg
16 051	S202 G-BNC	1 1/2	180	10,9
16 052	S202 G-CNC	2	280	10,9



### Regulator, PN 25

- admission pressure – up to 25 bar
- capacity – up to 12 kg/h

### Tank-regulator combination

- 1<sup>st</sup> and 2<sup>nd</sup> Stage, consisting of: middle pressure regulator (1. Stage) with emergency shut-off valve (SAV)
- Low pressure regulator (2. Stage) with relief valve with connection for pressure tap (SBV) with emergency supply connection and check plug



### Medium pressure regulator, PN 40 (1<sup>st</sup> stage)

- flanges acc. to DIN 2635
- body of steel GS-C25
- admission pressure – up to 16 bar
- back pressure – 0,7...7,0 bar
- set pressure – 1,5 bar (standard version)

FAS No.	Connection		Back pressure, mbar	Weight, kg
	Inlet	Outlet		
16 060	POL	G 3/4 female	50	2,9
16 223	POL	R 3/4 female	30	3,2

FAS No.	Size	Weight, kg
16 101	DN 25	11,0

**Low pressure regulator (2<sup>nd</sup> stage)**

- emergency shut-off valve (SAV)
- connection for pressure tap (SBV)
- admission pressure – up to 25 bar



FAS No.	PN	Capacity, kg/h	Connection, "		Back pressure, mbar	Weight, kg
			Inlet	Outlet		
16 065	2,5	12	G 1/2 female	G 1/2 female	50	1,7
16 066	2,5	24	G 3/4 female	G 3/4 female	50	2,0
16 067	4,0	60	G 3/4 female	G 3/4 female	50	2,4
16 224	2,5	12	G 1/2 female	G 1/2 female	30	2,5

**Medium pressure regulator, PN 40 (1<sup>st</sup> stage)**

- emergency shut-off valve (SAV)
- connection for pressure tap (SBV)
- admission pressure – up to 25 bar
- with device male against freezing
- emergency supply connection
- admission pressure – up to 25 bar
- capacity – up to 24 kg/h



FAS No.	Back pressure, bar	Connection		Weight, kg
		Inlet	Outlet	
16 027	2,0	POL	G 1/2 female	3,1
16 028	0,7	POL	G 1/2 female	2,6

**Medium pressure regulator, PN 40 (1<sup>st</sup> stage)**

- connection for pressure tap (SBV)
- admission pressure – up to 25 bar
- emergency supply connection
- pressure gauge
- admission pressure – up to 25 bar
- capacity – up to 60 kg/h



FAS No.	Back pressure, bar	Connection		Weight, kg
		Inlet	Outlet	
16 029	0,7...2,0	POL	G 3/4 female	3,3
16 069	0,7...2,0	G 1/2 female	G 3/4 female	3,3

**Medium pressure regulator, PN 25 (1<sup>st</sup> stage)**

- emergency shut-off valve (SAV)
- connection for pressure tap (SBV)
- admission pressure – up to 25 bar
- pressure gauge



FAS No.	Inlets pressure, bar	Back pressure, bar	Capacity, kg/h	Connection, "		Weight, kg
				Inlet	Outlet	
16 081	1,5...16	0,8	100	G1 female	G1 female	4,0
16 082	2,5...16	1,5	150	G1 female	G1 female	4,0
16 083	3,8...16	2,8	150	G1 female	G1 female	4,0

**Emergency shut-off valve (SAV) PN 25, adjustable**

- also with diaphragm-fracture protection
- material – cast iron GGG 40



FAS No.	Stage connection, DN	Stage	Setting range, bar	Factory setting, bar	Dimensions, mm		Weight, kg
					Length	Height	
16 111	DN 25	PN 16	0,05...0,25	0,10	160	240	11,0
16 112	DN 50			0,10	230	245	16,0
16 113	DN 80			0,10	310	285	26,0
16 115	DN 25		0,20...0,80	0,50	160	240	11,0
16 116	DN 50			0,50	230	245	16,0
16 117	DN 80			0,50	10	285	26,0
16 119	DN 25	PN 40	0,60...6,60	3,00	160	240	11,0
16 120	DN 50			3,00	230	245	16,0
16 121	DN 80			3,00	310	285	26,0

**Low pressure regulator, PN 4 (2<sup>nd</sup> stage)**

- flange connection acc. to DIN 2633
- body of cast iron GGG 40 and GD-AL Si 12
- inlet pressure – 0,35...4,00 bar
- operating temperature – 15 to +60°C
- emergency shut-off valve
- capacity – size DN 25 up to 70 kg/h; size DN 50 up to 520 kg/h

FAS No.		Size, DN	Back pressure, mbar	Factory setting, mbar	Connection, "	Length, mm	Weight, kg
Type A	Type B						
16 135	16 139	25	35...140	50	G ¾"	160	6,0
16 136	16 140	25	70...280	150	G ¾"	160	6,0
16 137	16 141	25	140...420	300	G ¾"	160	6,0
16 156	16 161	50	30...70	50	G 1"	200	14,0
16 157	16 162	50	70...140	100	G 1"	200	14,0
16 159	16 164	50	140...300	200	G 1"	200	14,0
16 158	16 163	50	210...450	250	G 1"	200	14,0
-	16 144	50	30...450	300	G 1"	200	14,0

**Type:**

- A – with emergency shut-off valve for upper limit switch
- B – with emergency shut-off valve for upper and lower limit switches and relief valve, relief valve connection for pressure tap, vent pressure permanently set 30 mbar above outlet pressure



# Safety relief valves

## Safety relief valve

- spring-loaded relief valve
- thread connection
- plastic protection cap
- body of brass



## Check device for safety relief valves

- for exchange of relief valves without emptying of tank
- seal
- body of brass



FAS No.	Type (RegO)	Connection	Total height, mm	Hexagon size, mm	Flow capacity, m <sup>3</sup> /min	Adjusted at (bar)	Weight, kg
28 301	RS3131	3/4" M.NPSM	85	46	48,9	17,2	1,0
28 303	RS3132	1" M.NPSM	129	60	77,5	17,2	1,0
28 305	RS3135	1/2" M.NPSM	141	68	118,0	17,2	1,0
28 382	RS3145	M45×2	139	68	187,2	15,6	1,0
28 869	RS3136	M36×2	135	60	134,3	15,6	1,0
28 875	RS3136	M36×2	135	60	134,3	17,0	1,0
90 904	RS3145	M45×2	139	68	187,2	17,0	1,0

FAS No.	Type (RegO)	Valve type	Internal thread	External thread	Total height, mm	Hexagon size, mm	Weight, kg
28 306	CD35	RS3135	1 1/4" F.NPSM	2" M.NPT	59	62	0,5
28 387	CD31	RS3131	3/4" F.NPSM	1 1/4" M.NPT	59	46	0,5
28 388	CD32	RS3132	1" F.NPSM	1 1/4" M.NPT	59	46	0,5
28 389	CD45	RS3145	M45×2	2" M.NPT	59	62	0,5
28 854	CD36	RS3136	M36×2	1 1/4" M.NPT	58	52	0,5

## Adaptor

for attachment of vent piping



FAS No.	Type RegO	For safety relief valve	Material	Connection, "	Pic.	Weight, kg
15 331	3129-10	RegO 3129	Brass	1/2 NPT female	1	0,06
15 334	7534-20	RegO 7534		3 NPT female	2	1,00
15 336	3132-10	RegO 3132		1 1/4 NPT female	1	0,20
15 328	3131-10	RegO 3131		1 NPT female		0,20
15 329	3133-10	RegO 3133		2 NPT female		0,50
15 330	3135-10	RegO 3135		2 NPT female		0,40
15 332	-	SV-A 12, A 22, A 23 SV-A 24, A 26, SV 805		1/2 NPT female	3	0,06
15 333	-	SV 486		Rp 1 1/2 female	4	0,20
15 335	-	SV-A 3		Rp 1 1/2 female	3	0,30
15 337*	-	SV-A 12ES, A 14ES, SV-A 16ES, SV 805		1/2 NPT female		0,06
15 338*	-	SV-A 12ES, A 14ES	1/2 NPT female	0,06		

**Safety relief valves**

for pipelines, mobile and stationary tanks, multivalves and duoports

- without protection cap

Please indicate the required setting pressure when placing your order. Valves 15 281, 15 291 and 15 292 – without threaded connection for vent piping. Order number is depending on setting pressure.



FAS No.	Type RegO	Connection NPT, "	Pressure range (bar)	Material	Pic.	Weight, kg	
15 281	RegO 3127	1/4	3...44	Brass	1	0,1	
15 291	RegO SS8001	1/4	10...31	Stainless steel		0,1	
15 292	RegO SS8002	1/2	10...31			0,1	
15 282	RegO 3129	1/2	4...31	Brass		0,1	
15 293	RegO SS8021	1/4	10...31	Stainless steel		0,1	
15 294	RegO SS8021	1/2	10...31		0,1		
15 284	RegO 3131	3/4	2...27	Brass	2	0,5	
15 287	RegO W3132	1	3...34			1,2	
15 288	RegO 8684	1	12...21		3	0,6	
15 289	RegO 8685	1 1/4	7...20			1,0	
15 311	RegO 3132	1 1/4	2...27		2	1,3	
15 285	RegO 3135	1 1/4	7...19			1,5	
15 312	RegO 3133	1 1/2	6...19		3	2,1	
15 314	RegO 7573	2	6...31			4,4	
15 315	Fisher H280/H281...	2	10...25			4,2	
15 316	RegO A8434 Fisher H720/H721	2	10...25		Steel	4	2,1
15 286	RegO A3149	2 1/2	2...21				2
15 317	RegO A8436 Fisher H730/H731	3	10...25			5	5,2

**Protective cap for relief valve**

FAS No.	Ventil Type	For relief valve type	Material	Weight, kg	FAS No.	Ventil Type	For relief valve type	Material	Weight, kg
15 403	RegO 3131-40	RegO 3131	Rubber	0,01	15 414	RegO A8436-11B	RegO A8436	Rubber	0,10
15 405	RegO 7545-40	RegO 3127, 3129		0,05	15 415	RegO 3133-40	RegO 3133		0,05
15 406	RegO 3132-40	RegO 3132	Steel	0,15	15 416	RegO 3149-40	RegO A3149		0,10
15 407	RegO 7534-40	RegO 7534	Rubber	0,37	15 417	RegO 3135-40	RegO 3135		0,10
15 408	RegO 7584-40	RegO 8684		0,09	15 401	-	SV-A 12/A 22/A 23/A 24/A 26/12ES/14ES/16 ES, SV 805	Plastics	0,01
15 409	RegO 7585-40	RegO 8685		0,14					
15 411	Fisher P297	Fisher H720/721		0,10	15 404	-	SV-A 3		0,01
15 412	Fisher P298	Fisher H730/731		0,15	15 410	-	SV 486, SV 741		0,09
15 413	RegO A8434-11B	RegO A8434		0,31					



## Excess flow valves • Back pressure check valves

### Excess flow valve PN 25

- NPT-thread

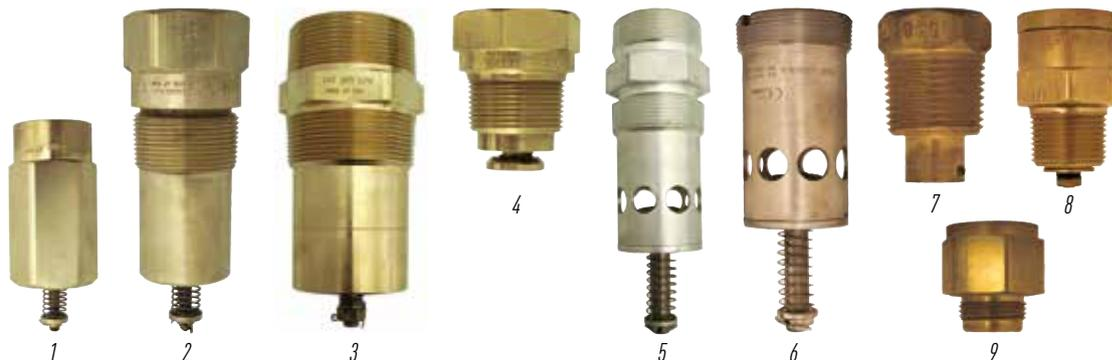

FAS No.	Type	Connection, "		Closing flow			Weight, kg	Pic.
		Inlet NPT	Outlet NPT	Liquid, approx. U/min	Vapor, approx. Nm <sup>3</sup> /h			
					at 1,7 bar	at 7,0 bar		
12 001	1519 A2	1	1	95	140	250	1,54	1
12 002*	A1519 A2	1	1	95	140	250	2,50	1
12 003	1519 A3	1 ½	1½	225	325	570	1,54	1
12 004	1519 B4	2	2	510	784	1420	2,50	1
12 031	1519 A4	2	2	378	512	925	2,50	1
12 005*	A1519 B4	2	2	510	784	1420	2,50	1
12 006*	A1519 A6	3	3	850	1270	2350	5,27	1
12 007*	FAS	3	3	1190	1780	3290	5,50	1
12 008	1519 C2	1½ male /1 G	1 female	95	140	250	1,10	2
12 009	-	3 male	3 male /2 female	985	1400	2385	4,50	3
12 010*	A2137 A	2 male /1¼ female	2 male /1¼ female	265	396	707	1,60	3
12 011	2139 A	3 male /2 female	3 male /2 female	620	750	1300	4,50	3
12 032	12472	¾	¾	15	20	35	0,15	4
12 012	3272 E	¾	¾	30	40	75	0,18	4
12 041	3272 F	¾	¾	48	77	135	0,15	4
12 013	3272 G	¾	¾	76	105	195	0,18	4

see next page

FAS No.	Type	Connection, "		Closing flow			Weight, kg	Pic.
		Inlet NPT	Outlet NPT	Liquid, approx. l/min	Vapor, approx. Nm <sup>3</sup> /h			
					at 1,7 bar	at 7,0 bar		
12 014*	A3272 G	¾	¾	76	105	195	0,18	4
12 042	3282 A	1¼	1¼	110	145	270	0,36	4
12 015	3282 C	1¼	1¼	190	255	461	0,36	4
12 016*	A3282 C	1¼	1¼	190	255	461	0,40	4
12 017	7574	1½	1½	340	430	795	0,68	4
12 018	3292 B	2	2	378	512	925	1,04	4
12 019*	A3292 C	2	2	462	625	1064	1,27	4
12 046*	A3500 L4	2	-	290	435	650	0,90	6
12 047*	A3500 N4	2	-	480	650	1170	0,90	6
12 022*	A3500 P4	2	-	568	863	1470	0,90	6
12 023*	A3500 R	3	-	568	908	1570	1,86	6
12 048*	A3500 T6	3	-	770	1024	1850	1,86	6
12 024*	A3500 V6	3	-	950	1446	2510	1,86	6
12 025*	A4500 Y8	4	-	1890	2518	4360	3,31	6
12 028*	A8523	¾	¾	57	146	250	0,23	5
12 043*	A8525	¼	1¼	134	290	525	0,60	5
12 044*	A7537 L4	2AG	2 male /1¼ female	284	432	735	0,60	5
12 029*	A7537 P4	2AG	2 male /1¼ female	568	863	1470	1,54	5
12 030*	A7539 V6	3AG	3 male /2 female	946	1446	2150	4,68	5
<b>For pressure gauge</b>								
12 038	2884 D	¾	¼	-	-	-	0,13	7
<b>Check-Lock</b>								
12 033	7572 FC	¾	¾	75	-	-	0,23	8
12 034	7580 FC	1¼	¾	132	-	-	0,50	8
<b>Check-Lock adaptor</b>								
12 037	7572 C-14A	¾	¾	-	-	-	0,10	9

\*The indicated vapor closing flows refer to the normal condition of 15°C and 762 torr.

**Excess flow valve PN 40**

type FAS-F, for installation between two flanges

- body and spring of stainless steel

**Type:**

- A – Standard execution
- B – With stronger spring

*The minimum flow rate should be twice as high as the maximum pumping capacity*

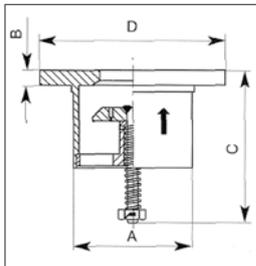

FAS No.	Type A	Size, "	Suitable for flanges	Closing flow propane, approx. l/min	Dimensions				Weight, kg
					A	B	C	D	
12 069		1¼	DN 32	90	30	10	60	75	0,6
12 070		1	DN 25	45	25	10	43	68	0,3
12 071		2	DN 50	167	48	13	85	92	0,9
12 072		2½	DN 65	224	60	13	94	105	1,3
12 073		3	DN 80	378	76	13	96	127	1,8
12 074		1½	DN 40	125	36	13	70	80	0,8
12 075		4	DN 100	791	97	16	118	157	3,3
12 076		5	DN 125	1257	121	16	151	186	5,0
12 077		6	DN 150	1764	142	19,6	183	216	8,4
12 078		8	DN 200	2388	190	20	211	270	12,9
12 079		10	DN 250	4035	245	22,5	285	323	23,7
FAS No.	Type B	Size, "	Suitable for flanges	Closing flow propane, approx. l/min	Dimensions				Weight, kg
					A	B	C	D	
12 081		2	DN 50	208	48	13	85	92	0,9
12 082		2½	DN 65	435	60	13	94	105	1,3
12 083		3	DN 80	606	76	13	96	127	1,8
12 085		4	DN 100	1287	97	16	118	157	3,3
12 086		5	DN 125	1567	121	16	151	186	5,0
12 087		6	DN 150	2911	142	19,6	183	216	8,4
12 088		8	DN 200	3217	190	20	211	270	12,9
12 089		10	DN 250	6185	245	22,5	285	323	23,7

**Back pressure check valve PN 40**

- flange connection acc. to DIN 2635
- body of cast steel GS-C25
- disc of stainless steel



FAS No.	Size, DN	Length, mm	Height, mm	Weight, kg
12 511	15	130	66	3,6
12 512	20	150	75	4,5
12 513	25	160	80	5,5
12 514	32	180	88	8,0
12 515	40	200	105	11,5
12 516	50	230	115	14,0
12 517	65	290	135	23,0
12 518	80	310	145	30,0
12 519	100	350	175	47,0
12 520	125	400	215	70,0
12 521	150	480	240	96,0

**Back pressure check valve PN 25**

- with NPT-thread
- metallic sealed
- sitting position variably



FAS No.	Type	Connection NPT	Capacity l/min. at 0,7 bar	Material	Pic.	Weight, kg
12 501	3146	3/4	60	Brass	1	0,18
12 502*	A3146	3/4	60	Steel	1	0,23
12 503	3176	1 1/4	150	Brass	1	0,36
12 504*	A3176	1 1/4	150	Steel	1	1,00
12 505	6586 C	2	1020	Brass	2	0,90
12 506*	A3186	2	662	Steel	1	1,27
12 507*	A3196	3	1600		1	2,81
12 508*	A6586 C	2	1020		2	1,02
12 509*	A3400 L4	2	1200		3	1,00
12 510*	A3400 L6	3	2300		3	1,90
28 819	A3187 S	2	416		4	1,20
28 896	A3198 S	2	1098		5	4,60

**Back pressure check valve PN 40**

- for installation between two flanges
- soft seal

**Type:**

- A – housing material 1.4317, soft seal made of viton, for propane / butane
- B – housing material 1.4317, soft seal made of viton, for propane / butane, with type approval
- C – housing material 1.4552, with PTFE-special seal for DME, refrigerant and NH<sub>3</sub>, with type approval



FAS No.			Size, DN	Length, mm	Weight, kg
Type A	Type B	Type C			
12 531	12 541	12 561	15	16	0,12
12 532	12 542	12 562	20	19	0,18
12 533	12 543	12 563	25	22	0,29
12 534	12 544	12 564	32	28	0,50
12 535	12 545	12 565	40	32	0,66
12 536	12 546	12 566	50	40	1,23
12 537	12 547	12 567	65	46	1,55
12 538	12 548	12 568	80	50	2,35
12 539	12 549	12 569	100	60	3,63

K

## Filling, quick-acting filling valves • Unloading adaptors • Fittings

### Filler valve PN 25

- brass
- with double back pressure check valve
- brass cap
- one-piece housing

FAS No.	Type	Dimensions, "		Pic.	Weight, kg
		Inlet	Outlet		
13 000	70321	1¼ ACME	¾ NPT	1	0,4
13 006	481	1¼ ACME	1½ NPT	1	0,5



### Filler valve PN 25

- brass
- with double back pressure check valve
- brass cap
- two-piece housing

FAS No.	Type	Dimensions, "		Pic.	Weight, kg
		Inlet	Outlet		
13 001	7547 BC	1¼ ACME	¾ NPT	1	0,4
13 002	7579 C	1¼ ACME	1½ NPT	2	0,6
13 003	6579 C	1¼ ACME	1½ NPT	2	0,6
13 004	6587 EC	2¼ ACME	2 NPT	3	2,3
13 005	3197 C	3¼ ACME	3 NPT	3	6,5



### Filler valve PN 25

- brass
- with single back pressure check valve
- brass cap
- two-piece housing

FAS No.	Type	Dimensions, "		Pic.	Weight, kg
		Inlet	Outlet		
13 008	6584 C	2¼ ACME	2 NPT	4	1,4
13 009	3194 C	3¼ ACME	3 NPT	4	4,3



### Safety filler coupling PN 25

- brass
- back pressure check valve

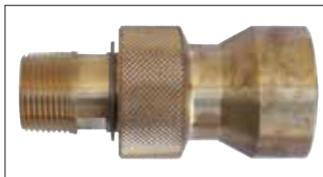

FAS No.	Inlet NPT, "	Outlet ACME, "	Length, mm	Weight, kg
13 025	1 NPT	1¼ ACME	120	1,5
13 026	¾ NPT	1¼ ACME	59	0,3

**Vapor equalizing valve, PN 25**

- brass
- excess flow valve
- brass cap

FAS No.	Type	Dimensions "		Pic.	Weight, kg
		Inlet	Outlet		
13 011	7573 AC	1¼ ACME	¾ NPT	1	0,3
13 012	3183 AC	1¾ ACME	1½ NPT	2	0,9
13 013	FAS	2¼ ACME	2 NPT	-	2,5
13 077 <sup>1</sup>	7573 D	1¼ ACME	¾ NPT	-	0,2
13 069 <sup>1</sup>	3183 AC	1¾ ACME	1½ NPT	3	0,8

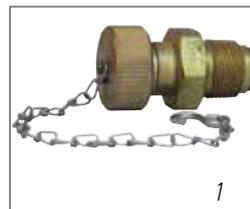
**Vapor equalizing valve, PN 25**

- brass
- excess flow valve

FAS No.	Type	Dimensions "		Weight, kg
		Inlet	Outlet	
13 015	FAS	2¼ ACME	2 NPT	1,4

**Quick-Acting shut-off valve, PN 25**

- housing of ductile iron – ASTM A395



FAS No.	Type	Execution	Inlet "	Outlet "	Weight, kg
13 022*	A7707 L	Straight	1 NPT	1 NPT	1,7

**Coupling, PN 25**

- for vapor equalizing valves
- brass



FAS No.	Type	Dimensions "		Weight, kg
		Type A	Type B	
13 064	3171 A	½ NPT	1¼ ACME	0,17
13 065	3181	¾ NPT	1¾ ACME	0,29
13 066	3181 A	1 NPT	1¾ ACME	0,34
13 067	3191	1¼ NPT	2¼ ACME	0,85

**Quick-Acting valve, PN 25**

- material steel
- execution – angle form
- with safety filling device
- closing position with lock
- suitable for LPG and ammonia



FAS No.	Type Reg 0	Inlet	Outlet	Weight, kg
13 0351	A7793A	¾" NPT	1¾"	2,9
13 035	A7797A	1" NPT	ACME	2,8

**Spanner wrench for ACME-coupling**

Other sizes of spanner wrenches on request

FAS No.	Type	Size of jaw, "	Weight, kg
13 126	P120B	2¼, 3¼, 4¼	0,52
13 127	3195-50	2¼, 3¼	0,45



**Nozzle PN 25**

- with safety filler coupling
- back pressure check valve



Nozzle RegO/FAS



Nozzle LG/FAS



Nozzle Nettuno

Nozzle LG/FAS  
with outlet DISH**Coupling PN 25**

- both sides with ACME-male thread



FAS No.	Type	Dimensions, "	Material	Weight, kg
13 071	FAS	1 1/4 ACME	Brass	0,14
13 072	5765 M	1 1/4 ACME	Brass	0,36
13 073	5767 M	2 1/4 ACME	Brass	0,59
13 074	5769 M	3 1/4 ACME	Brass	1,35
13 075	FAS	4 1/4 ACME	Steel	3,86

FAS No.	Type	Inlet	Outlet	Weight, kg
13 018	RegO/FAS	1 NPT female	1 1/4 ACME	2,9
13 031	RegO/FAS			2,9
13 037	LG/FAS	3/4 NPT female		2,0
13 038	LG/FAS	M 30×1,5 left male		2,0
13 023	LG/FAS	3/4 NPT female		2,0
13 024	LG/FAS	M 30×1,5 links male		2,0
13 086	Nettuno T4	G1 female	Clamp	1,4
13 039	Nettuno T3		Clamp	1,4
13 516	DV-V10 (NL)	3/4 NPT female	Bajonett	1,6
13 529	LG/FAS		DISH	2,0
13 200	LG/FAS	EUROPA Connection		2,0
13 498	Nettuno R 1	G1 female	Clamp	1,4

**Reducer-coupling PN 25**

- both sides with ACME-connection



FAS No.	Type	Dimensions "		Material	Weight, kg
		A - male	B - female		
13 078	FAS	1 1/4 ACME	2 1/4 ACME	Brass	0,73
13 079	A5776	1 1/4 ACME	3 1/4 ACME	Steel	2,27
13 080	FAS	3 1/4 ACME	4 1/4 ACME	Steel	3,45

Other quick-acting shut-off valves for other countries, adaptors or connections on request.

**Coupling PN 25**

for filler valve

**Type:**

- A – standard type
- B – hose coupling

\*Single ACME union nuts are available on request



FAS No.		Type	Dimensions		Material	Weight, kg
Type A	Type B		A	B		
13 050*	13 280*	A3175	¾ NPT	1¼ ACME	Steel	0,35
13 051	-	3175 B	¼ NPT	1¼ ACME	Brass	0,40
13 052	-	3175	¾ NPT	1¼ ACME	Brass	0,35
13 053	-	3175 A	1 NPT	1¼ ACME	Brass	0,32
13 054*	13 281*	A3175A	1 NPT	1¼ ACME	Steel	0,36
13 055	-	3185	1¼ NPT	2¼	Brass	0,77
13 056*	13 282*	A3185	1¼ NPT	2¼	Steel	0,73
13 057	-	3195	2 NPT	3¼ ACME	Brass	1,95
13 058*	13 283*	A3195	2 NPT	3¼ ACME	Steel	1,95
13 059*	13 284*	FAS	3 NPT	3¼ ACME	Steel	2,90
13 060*	13 285*	FAS	3 NPT	4¼ ACME	Steel	3,45

**Coupling PN 25**

- with back pressure check valve
- brass

**Cap plug PN 25**

- with chain



FAS No.	Type	Dimensions	Material	Weight, kg
13 091	FAS-1	1¼ ACME	Brass	0,10
13 092	FAS-2	1¾ ACME	Brass	0,15
13 093	FAS-3	1¾ ACME	Steel	0,36
13 094	3184-90	2¼ ACME	Brass	0,86
13 095	A3184-90	2¼ ACME	Steel	0,82
13 096	3194-90	3¼ ACME	Brass	1,92
13 097	A3194-90	3¼ ACME	Steel	1,95
13 098	FAS-4	4¼ ACME	Steel	2,95
13 099	3144-91	1¼ ACME	Plastics	0,10
13 100	3174-93	1¾ ACME	Plastics	0,10

FAS No.	Type	Dimensions		Pic.	Weight, kg
		Inlet	Outlet		
13 061	7141 F	1¼ ACME female	¼ NPT female	1	0,20
13 062	7141 M	3/8 NPT female	1¼ ACME male	2	0,20
13 068	7193L-10A	1¼ ACME female	¼ ACME male	3	0,85

**Filler hose adaptor PN 25**

- for installation between inner tube valve and filler valve
- vent valve

**Type:**

- A – standard type of brass
- B – with ball valve of steel, connection parts of brass



FAS No.	Type	Inlet, "	Outlet, "	Length, mm	Pic.	Weight, kg
---------	------	----------	-----------	------------	------	------------

**Type A**

13 111	7577V	1 3/4 ACME female	1 3/4 ACME male	85	1	0,60
13 107	FAS	1 3/4 ACME female	1 3/4 ACME male	97	1	0,60

**Type B**

13 110	FAS	1 3/4 ACME female	1 3/4 ACME male	170	2	1,50
--------	-----	-------------------	-----------------	-----	---	------

**Unloading adaptor PN 25**

for discharging of LPG tanks



FAS No.	Type	Inlet, "	Outlet, "	Form	Pic.	Weight, kg
---------	------	----------	-----------	------	------	------------

13 112	FAS	1 3/4 ACME female	1 3/4 ACME male	Angular	1	1,00
13 113	3119A	1 3/4 ACME female	1 3/4 ACME male	Straight	2	1,20
13 114	M450A	1 3/4 ACME female	1 3/4 ACME male	Angular	1	1,05
13 115	FAS	1 3/4 ACME female	3/4 NPT female	Angular	1	0,90

**Safety breakaway coupling**

for hoses PN 25 breakaway protection for high-pressure LPG hoses

- thread connections
- both halves sealed when separated

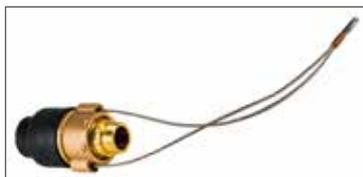

FAS No.	Type	Connection A+B, "	Length, mm	Material	Weight, kg
---------	------	-------------------	------------	----------	------------

13 131	ARK19	3/4 NPT female	90	Red brass	0,8
13 132	A2141A6L	3/4 NPT female	98	Steel	0,6
13 133	A2141A8L	1 NPT female	115	Steel	1,4
13 134	A2141A10	1 NPT female	142	Alu	2,2
13 135	A2141A16	2" NPT female	363	Alu	11,3
13 208	FAS	3/4 NPT female	155	Steel	1,2

**Breakaway coupling for hose LPG 19**

13 105	Walther	3/4 NPT female	163	Stainless steel	1,3
--------	---------	----------------	-----	-----------------	-----

**Safety breakaway coupling PN 40**

for loading arms

- flanges acc. to DIN 2635
- entirely of stainless steel
- no welds
- both valves sealed when separated
- disconnecting over pull cable and shear pin mechanism

**Type:**

- A – Viton O-rings for propane / butane (LPG)
- B – O-rings (PTFE encapsulated) for ammonia (NH<sub>3</sub>)

Models with seals suitable for other products are available on request



Pull cable activating mechanism with fastening elements

FAS No.	Execution
13 181	Cable length in accordance to project specifications

Spare parts kit with shear pins and O-rings

FAS No.		Execution
Type A	Type B	
13 191	13193	for DN 50
13 192	13194	for DN 80

FAS No.		Type	Size, DN	Length, mm	Weight, kg
Type A	Type B				
13 171	13 173	ERC 2"	50	200	18,0
13 172	13 174	ERC 3"	80	360	30,0



FAS No.	Type	Length, mm	Inlet / Outlet, NPT	Capacity, l/min	Breaking moment, N•m	Weight, kg
13 7200	SBK	127	¾" IG / ¾" IG	40	565	0,81
13 7231	RIS-Shear-LPG1	160	1" AG / 1" IG	up to 130	420	1,13

**Seal PN 40**

for filling fittings

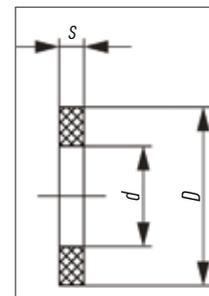

FAS No.	Connection	Dimensions, mm		
		D	d	s
13 121	1 ¼ ACME	23	13	3
13 122	1 ¾ ACME	34	23	3
13 123	2 ¼ ACME	46	36	3
13 124	3 ¼ ACME	72	54	3
13 125	4 ¼ ACME	94	73	3

**Breakaway coupling, PN 25**

- housing: brass
- for LPG dispensers
- to secure the pipework in the event of in the event of unintentional, accidental tearing of the dispenser
- self-closing valve, can be closed on both sides when disconnected, release via sleeve
- with predetermined breaking point
- not reusable after release

In accordance with DIN EN 14678-1 chapter 4.5.1.2.

Documentation: GIP, type SBK with DVGW test

**Breakaway coupling, PN 25**

- for high-performance dispensers
- housing: brass
- clamping jaws: aluminium
- for mounting on the base frame of the dispenser to secure the pipework in the event of accidentally knocking over the petrol pump
- self-closing valve, shutting off on both sides when disconnected, release via sleeve
- with predetermined breaking point
- not reusable after release

Documentation: EC Declaration of Conformity according to ATEX directive



Male part



Female part



In coupled position (thread execution)

### Quick-acting dry breakaway coupling PN 25 for loading / unloading of rail / road tankers

- body of stainless steel 1.4408
- with NBR flat compression seals; with cam lever

Type: A – male part; B – female part

Order-No.	Size, DN	Connection-Flange	Length, mm	Weight, kg
<b>Mann Tek-DGC / male part (tank connection)</b>				
13 9145	25	25 (DIN 2635)	75	1,4
13 9146	50	50 (DIN 2635)	81	3,5
13 9147	80	80 (DIN 2635)	112	5,5
13 9125	25	1" (ANSI / 300 lbs)	75	1,5
13 912	50	2" (ANSI / 300 lbs)	81	3,2
13 913	80	3" (ANSI / 300 lbs)	112	5,5
13 9153	25	1" (NPT IG)	77	0,7
13 915	50	2" (NPT IG)	102	1,0
13 916	80	3" (NPT IG)	144	3,0
<b>Mann Tek-DGC / female part (hose connection)</b>				
13 9140	25	25 (DIN 2635)	169	3,4
13 9117	50	50 (DIN 2635)	218	6,0
13 9118	80	80 (DIN 2635)	267	13,2
13 9119	25	1" (ANSI / 300 lbs)	168	3,4
13 9111	50	2" (ANSI / 300 lbs)	218	5,7
13 9113	80	3" (ANSI / 300 lbs)	263	13,3
13 8010	25	1" (NPT IG)	133	1,9
13 911	50	2" (NPT IG)	155	2,9
13 9121	80	3" (NPT IG)	194	8,1



### Safety breakaway coupling for hoses PN 25

- type approval, flanges acc. to DIN 2635
- stainless steel, Viton O-Rings
- no pressure-containing welds
- disconnects using 3 break pins
- max. angle of traction – 90°

Type approval is only valid during standard pull-off strength operation, other pull-off strengths are available on request.

FAS No.	Type, "	Size, DN	Length, mm	Standard breakload, kN	Weight, kg
13 150	APC 1½	25	163	–	4,0
13 151 <sup>1</sup>	APC 1½	32	163	6,99	5,0
13 152	APC 1½	40	163	–	6,0
13 153 <sup>1</sup>	APC 2½	50	200	14,98	12,0
13 154 <sup>1</sup>	APC 2½	65	200	14,98	13,0
13 156 <sup>1</sup>	APC 3	80	360	30,62	24,0
13 157	APC 4	100	340	–	38,0
13 158	APC 4	125	340	–	45,0
13 159	APC 6	150	380	–	100,0
13 160	APC 8	200	640	–	195,0
13 140	Steel safety cable with fastening elements				

### Breakspade kit with viton O-rings

13 161	for DN 25, DN 32 and DN 40 (1½")
13 162	for DN 50 and DN 65 (2½")
13 164	for DN 80 (3")
13 163	for DN 80 (4"), DN 100 and DN 125 (4")
13 165	for DN 150 (6")
13 166	for DN 200 (8")
13 197	Torque wrench with 2 nuts, setting range 4...12 N•m



## Strainers • Traps • Fine filters • Methanol dewatering equipment

### Strainer PN 40

- body of steel
- Y-type
- flange connection acc. to DIN 2635
- inner screen of stainless steel

#### Type:

- A – standard type
- B – with fine-mesh screen, mesh size 0,25 mm

*Other sizes and strainers in nominal pressure PN 16, or with ANSI flanges are available on request.*



FAS No. (type A)	Size, DN	Length, mm	Mesh size, mm	Weight, kg
14 001	15	130	0,60	2,0
14 002	20	150		3,0
14 003	25	160		4,0
14 004	32	180		6,0
14 005	40	200		8,0
14 006	50	230		11,0
14 007	65	290	1,20	15,0
14 008	80	310		24,2
14 009	100	350		28,0
14 010	125	400		44,0
14 000	150	480		62,0

FAS No. (type B)	Size, DN	Length, mm	Mesh size, mm	Weight, kg
14 011	15	130	0,25	2,0
14 012	20	150		3,0
14 013	25	160		4,0
14 014	32	180		6,0
14 015	40	200		8,0
14 016	50	230		11,0
14 017	65	290		15,0
14 018	80	310		24,2
14 019	100	350		28,0
14 020	125	400		44,0
14 040	150	480		62,0

**Strainer PN 40**

- type FAS-SFF
- body of cast steel GS-C 25 / GP 240GH
- Y-type with flanges acc. to DIN 2635 / EN 1092-1
- interior strainer made of stainless steel
- mesh size – 0,6 mm

FAS No.	Size, DN	Length, mm	Weight, kg
14 411	15	130	2,4
14 412	20	150	4,0
14 413	25	160	5,2
14 414	32	180	7,2
14 415	40	200	8,5
14 416	50	230	12,2
14 417	65	290	19,0
14 418	80	310	27,2
14 419	100	350	44,0
14 420	125	400	65,0
14 421	150	480	80,0

**Strainer PN 40**

- type FAS-SFF
- body of cast steel GS-C 25 / GP 240GH
- Y-type with flanges acc. to DIN 2635 / EN 1092-1
- interior strainer made of stainless steel
- execution with fine mesh filter, mesh – 0,25 mm

*Spare filter and seals are available on request*

FAS No.	Size, DN	Length, mm	Weight, kg	FAS No.	Size, DN	Length, mm	Weight, kg
14 451	15	130	2,4	14 457	65	290	19,0
14 452	20	150	4,0	14 458	80	310	27,2
14 453	25	160	5,2	14 459	100	350	44,0
14 454	32	180	7,2	14 460	125	400	65,0
14 455	40	200	8,5	14 461	150	480	80,0
14 456	50	230	12,2				

**Strainer PN 40**

- Y-type
- thread connection
- inner screen 0,25 mm of stainless steel
- body of steel GP 240 GH (1.0619)



FAS No.	Connection NPT, "	Length, mm	Weight, kg
14 0610	½	80	0,3
14 0620	¾	95	0,4
14 0630	1	100	0,8
14 0640	1 ¼	120	1,2
14 0650	1 ½	140	1,5
14 0660	2	180	2,4

**Strainer PN 40**

- for installation between flanges
- in short version acc. to DIN 3202
- cylindrical housing with two discharging screws
- body of steel (GP265GH (1.0425))
- mesh size – 1,0 mm



FAS No.	Size, DN	Length, mm	Diameter, mm	Weight, kg
14 091	40	40	92	1,1
14 092	50	42	107	1,3
14 093	65	46	127	1,5
14 094	80	50	142	2,3
14 095	100	60	168	2,8

**Trap**

for installation downstream from vaporizer unit

- connection 1" NPT female for liquid level sensors
- primed and painted

**All traps are fitted with:**

- a fine-mesh screen, mesh size 1,0 mm
- gas deflector
- drain valve



FAS No.	Connection	Contents, l	Length, mm	Weight, kg
14 121	½" NPT	2,9	160	6,0
14 122	¾" NPT	2,9	160	6,9
14 123	1" NPT	2,9	160	7,8
14 124	DN 25	2,9	220	8,7
14 125	DN 32	2,9	220	9,5
14 126	DN 40	2,9	225	10,1
14 127	DN 50	2,9	230	12,4
14 128	DN 65	12,5	330	26,8
14 129	DN 80	12,5	340	28,6
14 130	DN 100	12,5	350	31,7
26 130	Extra charge for level sensor (PN 25, connection 1" NPT male, approved for use in hazardous locations, Zone 0, with PTB-type approval, length of sensor: 66,5 mm)			
26 301	Extra charge for isolating switch amplifier (with intrinsically safe input and relay output, 1-channel)			
14 120	Extra charge for sealing of level sensor including pressure test			

**Filling device PN 25**

- for methanol
- FAS No. – FAS 14 085
- weight – 7,2 kg

**Consisting of:**

- Adapter, brass, 1¾" ACME with pin, for attachment to filler valve
- Shut-off valve, brass, ¾" NPT
- Vent valve, brass, ¼" NPT
- Methanol-pressure vessel, nominal capacity approx. 2 l
- Plug
- High-pressure LPG hose DN 10, length approx. 2 m
- Swivel POL adaptor for connection to service valve for gas withdrawal



**Drain device**

for draining of water from stationary pressure tanks

- volume approx. – 4 liters
- inlet flange acc. to DIN 2635
- primed and painted

**Type:**

- A – Angle valve of brass, 3/4" NPT with plug, relief valve of brass, type approval, 3/4" NPT, set pressure 25 bar
- B – Ball valve of steel, 1/2" NPT with plug, relief valve of stainless steel, type approval, 1/2" NPT, set pressure 25 bar

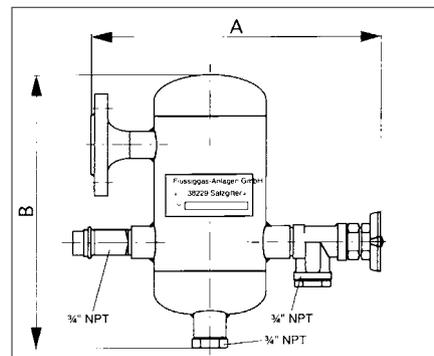

FAS No.		Size, DN	Dimensions, mm		Weight, kg
Type A	Type B		A	B	
14 151	14 156	15	310	300	5,2
14 152	14 157	20	310	300	5,5
14 153	14 158	25	310	300	5,7

**Fine-mesh filter PN 25 for stationary systems**

- primed and painted
- straight type
- connecting flanges acc. to DIN 2635
- fine-mesh screen – of stainless steel, mesh size of 0,125 mm
- connection – 1/2" female NPT, with plug

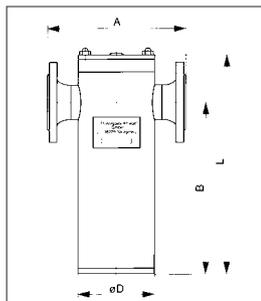

FAS No.	Size, DN	Dimensions, mm				Weight, kg
		A	B	D	L	
14 131	25	250	205	133	285	11,0
14 132	32	250	255	133	335	13,0
14 133	40	285	250	152	335	16,0
14 134	50	285	310	152	395	19,0
14 135	65	350	350	194	465	29,0
14 136	80	350	440	194	560	33,0
14 137	100	460	585	273	720	42,0
14 138	125	460	585	273	720	42,0
14 139	150	648	714	406	899	192,0
14 169	200	648	714	406	899	192,0

M

# Fittings for refilling facilities • Swivel joints • Loading arm stations

## Liquid and vapor transfer hose system in full hose system PN25

- standard connections for road tankers
- respectively for rail tankers
- tested at a hydrostatic pressure of 37,5 bar

### Type:

- A – Length 4 m
- B – Length 5 m

FAS No.		Execution
Type A	Type B	

### Filler hose for road tankers with safety relief valve 25 bar and venting device

25 021	25 221	High-pressure hose LPG 80, connections: one side ball valve DN 65 PN 40 with coupling 3/4" ACME with union nut and plug of brass, other side flange DN 80 PN 40 to DIN 2635
25 022	25 222	High-pressure hose LPG 50, connections: one side ball valve DN 50 PN 40 with coupling 3/4" ACME with union nut and plug of brass, other side flange DN 50 PN 40 to DIN 2635

### Vapor transfer hose for road tankers

25 023	25 223	High-pressure hose LPG 50, connections: one side ball valve DN 50 PN 40 with coupling 2 1/4" ACME with union nut and plug of brass, other side flange DN 50 PN 40 to DIN 2635
25 024	25 224	High-pressure hose LPG 32, connections: one side ball valve DN 32 PN 40 with coupling 2 1/4" ACME with union nut and plug of brass, other side flange DN 32 PN 40 to DIN 2635

### Filler hose for rail tankers with safety relief valve 25 bar and venting device

25 031	25 231	High-pressure hose LPG 80, connections: one side ball valve DN 65 PN 40 with lapped DIN flange DN 80 PN 40 and installed blind flange, other side flange DN 80 PN 40 to DIN 2635
--------	--------	--

### Vapor transfer hose for rail tankers without safety relief valves 25 bar and venting device

25 032	25 232	High-pressure hose LPG 50, connections: one side ball valve DN 50 PN 40 with lapped DIN flange DN 50 PN 40 and installed blind flange, other side flange DN 50 PN 40 to DIN 2635
--------	--------	--

## Complete hose system for applications in CIS and Baltic states

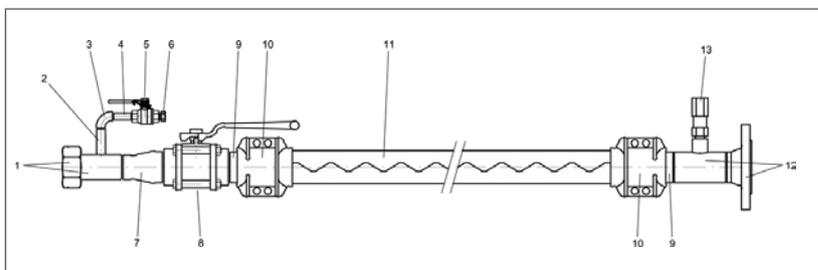

FAS 25 027 LPG-filling hose DN 50 in full hose system

FAS No.	Execution
25 027	LPG-filling hose DN 50 in full hose system with safety relief valve and tension release, length = 4 m, connections: ball valve DN 50 PN 40 with union nut M60×4 and plug on one side, other side flange DN 50 PN 40 to 2635, completely mounted
25 028	LPG-filling hose DN 50 in full hose system with safety relief valve and tension release, length = 4 m, connections: ball valve DN 50 PN 40 with union nut M60×4 and plug on one side, other side union nut M60×4, completely mounted
25 029	LPG-filling hose DN 50 in full hose system with safety relief valve and tension release, length = 5 m, connections: ball valve DN 50 PN 40 with union nut M60×4 on one side, other side flange DN 50 PN 40 to 2635, completely mounted
25 030	LPG-filling hose DN 32 in full hose system with safety relief valve and tension release, length = 10 m, connections: ball valve DN 32 PN 40 with union nut M60×4 and plug on one side, other side flange DN 32 PN 40 to 2635, completely mounted
25 037	LPG vapor transfer hose DN 32 in full hose system with safety relief valve and tension release, length = 4 m, connections: ball valve DN 32 PN 40 with union nut M60×4 and plug on one side, other side flange DN 32 PN 40 to 2635, completely mounted
25 039	LPG vapor transfer hose DN 32 in full hose system with safety relief valve and tension release, length = 7 m, connections: ball valve 1 1/4" with union nut M60×4 and plug on one side, other side flange DN 32 PN 40 to 2635, completely mounted
25 042	LPG-filling hose DN 50 in full hose system with safety relief valve and tension release, length = 7 m, connections: ball valve DN 50 PN 40 with union nut M60×4 and plug on one side, other side flange DN 50 PN 40 to 2635, completely mounted
93 016	Complete LPG high pressure hose line DN 50, PN 25, 2", electrical conductivity, temperature range: -40 up to +70°C, hose length = 4 m, connections: flange DN 50 PN 40 with ball valve DN 50, PN 40 on one side, other side flange DN 50 PN 40 to 2635, safety relief valve, excess flow valve, flange outside for welding
93 018	Complete LPG high pressure hose line DN 50, PN 25, 2", electrical conductivity, temperature range: -40 up to +70°C, hose length = 4 m, connections: flange DN 50 PN 40 with ball valve DN 50, PN 40 on one side, other side flange DN 50 PN 40 to 2635, safety relief valve, excess flow valve, flange outside for welding

### FAS 93 6808 complete hose cabinet for road tankers



FAS 93 680



FAS 93 6808

#### Liquid line: right

- M60×4 with cap
- pressure gauges with shut-off valve
- ball valve 1/2" NPT
- ball valve DN 50

#### Vapor line: left

- M60×4 with cap
- pressure gauges with shut-off valve
- ball valve 1/2" NPT
- ball valve DN 25



#### Torch for safe burning

of vapor and liquid LPG (FAS No. FAS 25 290)

- 3 removable supports, with brackets for fixing
- automatic ignition device and flash back arrestor
- 20 meters cable with plug
- solenoid valve 230 V 50 Hz in inlet
- connection 1 3/4" male ACME
- total height approx. 3500 mm, space required for erection approx. 9 m<sup>2</sup>

### Loading arm station PN 25 type FAS-G5

for the unloading of road tankers or rail tankers

- two product arms (liquid and vapor phase)
- connection for road tankers or rail tankers
- 10% X-ray of welding seams
- completely mounted and primed

#### Type:

- A – for Propan/Butan
- B – for Ammonia NH<sub>3</sub>

*Loading arm stations with other dimensions and ANSI-connections for other media on request.*

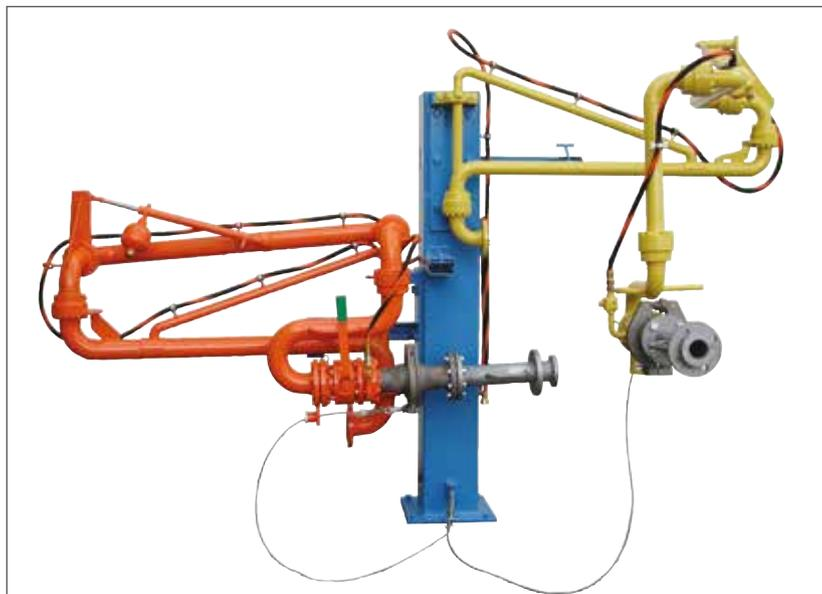

FAS No.		Execution
Type A	Type B	
25 302	25 307	Road tanker
25 304	25 309	Rail tanker
Additional Service		
25 392		Painting of the complete loading arms station
25 399		X-ray 100% of welding seams

#### Loading Arm Station

- Loading arm DN 80 (liquid phase), connection road tanker: coupling 3 1/4" ACME with union nut and blind plug
- Loading arm DN 50 (vapor phase), connection road tanker: coupling 2 1/4" ACME with union nut and blind plug
- Flanged ball valve DN 50 and DN 80, Fire-safe acc. to BS 6755 Part 2
- ERC-safety breakaway coupling DN 50 and DN 80 with release system
- Ball valve 1/2" NPT for tension release, vent hose line LPG 10 for propane / butane or flexible stainless steel hose line for ammonia NH<sub>3</sub>
- Support column with thrust bearing system and 2 parking position locks
- Hydraulic/pneumatic balance system for easy operation and handling

**Flexible loading arm****Type FAS**

for unloading of rail tankers  
(execution for Russia)

- 3 pcs. per rail tanker



*FAS 25 522:  
Filling nozzle*



FAS No.	Execution
93 268	Basic version: lapped flange DN 50, PN 40, socket 1 1/2" NPT – 2 pcs., flexible hose of stainless steel DN 40, PN 25, length 6 m, ball valve DN 40, PN 63, filling connection for rail tankers
<b>Additional accessories</b>	
12 081	Excess flow valve 2", Type FAS, 166 l, PN 40
13 135	Breakaway coupling for hoses, PN 25, 2" female NPT on both sides

**FAS 25 466: Loading arm station PN 25, Type FAS-G4**

for loading and unloading of road tankers

- two loading arms (liquid and vapor phases)
- 100% X-ray of welding seams
- completely mounted and primed
- execution – TKW

**Equipment:**

- Two loading arms DN 50, connection liquid phase with coupling 3/4" ACME with union nut and blind plug, connection vapor phase coupling 2 1/4" ACME with union nut and blind plug
- Flanged ball valve DN 50 PN 40, Fire-safe acc. to BS 6755 Part 2
- ERC-safety breakaway coupling DN 50 with release system
- Ball valve 1/2" NPT with hose line LPG 10 for venting
- Support column with thrust bearing system and 2 parking position locks



### Loading arm station PN 25, Type FAS-G7,

for loading and unloading of road tankers or rail tankers

- with one product arm (liquid phase)
- completely mounted and primed
- 10% X-Ray of welding seams

#### Type:

- A – for Propan/Butan
- B – for Ammonia NH<sub>3</sub>

#### Equipment:

- Loading arm DN 80/DN 50 for road tanker, connection ACME-coupling with union nut and blind plug or respectively connection lapped flange with blind flange for rail tankers.
- Flanged ball valve DN 50 or DN 80, Fire-safe acc. to BS 6755 Part 2
- ERC-safety breakaway coupling DN 50 with release system
- Ball valve 1/2" NPT for tension release, vent hose line LPG 10 for propane / butane or flexible stainless steel hose line for ammonia NH<sub>3</sub>
- Support column with thrust bearing system and 2 parking position locks
- Hydraulic/pneumatic balance system for easy operation and handling

FAS No.		DN	Execution	Connection
Type A	Type B			
25 451	25 468	80	TKW	3/4" ACME
25 452	25 469	80	EKW	DN80
25 401	25 464	50	TKW	2 1/4" ACME
25 402	25 465	50	EKW	DN50
25 519	-	80	FAS-RFP	DN50
25 520	-	50	FAS-RGP	DN50
25 521	Swivel joint 90°, connections 1 1/2" x 1 1/2" female NPT, with corrosion resistant metallic seal, max. operation pressure 25 bar, min. temperature -40° C			
<b>Additional service</b>				
25 391	Extra charge for painting of complete loading arm station			
25 398	X-ray 100% of welding seams			

**Swivel joint PN 25,  
3-piece body**

- straight construction of steel
- welding ends on both sides
- seals of PTFE



FAS No.	Size, DN	Length, mm	Weight, kg
25076	DN 50	170	8,8
25078	DN 80	175	12,0

Due to this 3-piece construction an exchange of the swivel joint head is possible without difficulties.

**Swivel joint PN 40,  
2-piece body**

- straight construction
- welding ends on both sides
- seals of PTFE



Type:

- A – of stainless steel for ammonia NH<sub>3</sub>
- B – of steel for propane / butane

FAS No.		Size, DN	Length, mm	Weight, kg
Execution A	Execution B			
25 064	25 084	DN 32	90	3,5
25 066	25 086	DN 50	145	7,2
25 068	25 088	DN 80	155	11,8

**Swivel joint PN 25**

for hose and pipe connections

- seals of PTFE

Type:

- A – angular construction 90°, steel, both sides female NPT
- B – straight construction, steel, both sides female NPT
- C – straight construction, steel, one side female NPT, other side male NPT male



FAS No.			Connection NPT, "	Weight, kg		
Type				Type		
A	B	C		A	B	C
25 161	25 171	25 182	3/4	3,2	2,2	0,9
25 162	25 172	25 183	1	3,2	2,2	0,9
25 163	25 173	25 186	1 1/4	3,0	2,0	1,2
25 164	25 174	–	1 1/2	5,9	5,4	–
25 165	25 175	–	2	5,6	5,0	–

**Road tanker connection**

(FAS-98124), PN 25, for liquid gas line of any LPG filling station

- connection M60×4 left, male with welding end DN 50
- welded neck flange DN 50
- cap M60×4 left, female
- weight – 2,9 kg
- completely welded, primed, painted and mounted

**Road tanker connection**

(FAS-98 127), PN 25, for liquid gas line of any LPG filling station

- connection M60×4 left, male with welding end DN 50, reducer DN 80 / DN 50
- welded neck flange DN 80
- cap M60×4 left, female
- weight – 5,9 kg
- completely welded, primed, painted and mounted



**Filling connection**

type FAS-RKSW-III (FAS-25522) for fixation of LPG-filling line to GUS-LPG-rail tankers

- for liquid and vapor phase
- without locking facility
- thread-less connection to rail tanker's side, with O-ring, pipe line side connection 1½" male NPT
- galvanized and tested for functioning

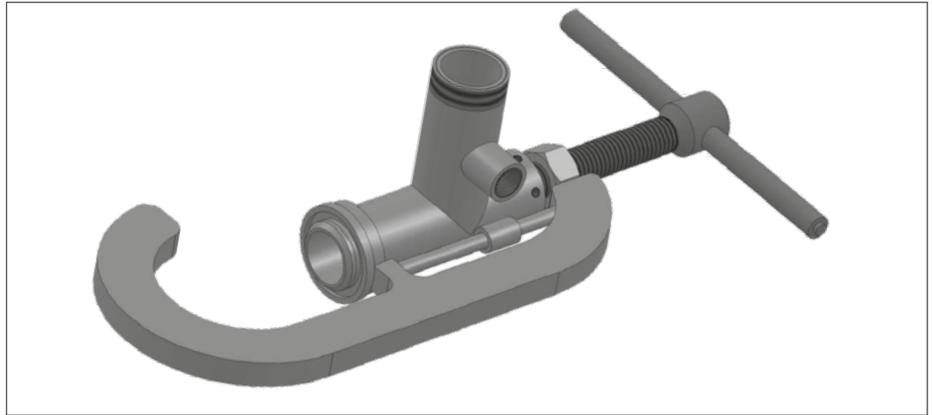
**Parts list**

- 1. Socket 1" NPT
- 2. Coupling
- 3. Spindle
- 4. Guide arm
- 5. Handle
- 6. Guide shell
- 7. Grease nipple M 10.1
- 8. Bracket
- 9. Guide ring
- 10. Guide pin
- 11. Guide screw nut

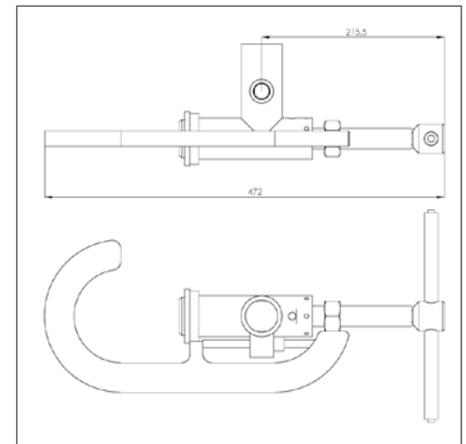
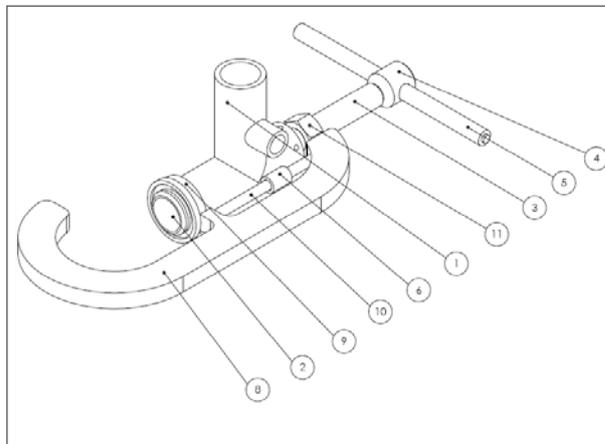

*Dimension drawing.*

N

# Electrical components • Gas alarms systems



1



2



4



3

## Control button IP 65 for controlling of electrical drives

- insulating box
- E Ex dem IIC T6

FAS No.	Type	Pic.
26 041	Emergency stop button with mushroom button actuator	1
26 042	ON-OFF push-button	2
26 043	ON-OFF push-button with indicating lamp	3
26 044	Emergency stop button with mushroom key-operated button actuator	4

## Control button

for installation outside of Ex-zone

- insulating box
- protection class IP 64

FAS No.	Type	Pic.
26 046	Emergency stop button with mushroom button actuator	1

## Electric torch

2,5 V for hazardous areas zone 1, protection class EEx ia e II C T6, batteries type I EC R 20



## Temperature measuring and monitoring system

(e.g. for vapor outlet in compressors)

- measuring amplifier with 2 adjustable limit outputs
- temperature indication
- intrinsically safe input circuit for PT 100
- connection PT100 – M18×1,5 female
- DIN resistors in 2-, 3- or 4-wire circuit
- potential-free outputs
- operating voltage 24 V DC
- installation in electrical switch box

FAS No.	Type
26 312	Resistance thermometer, PT 100
26 3140	Measuring amplifier PMT 50 Ex
26 316	Welding thermometer well, connection M18×1,5 female

## Beacon

for use in moist areas or outdoors  
AC 230 V, 50/60 Hz

FAS No.	Type	Weight, kg
26151	Without explosion protection	0,5
26152	With explosion protection	1,3



## Horn with powerful electromagnetic system

- 230 V / 50 Hz
- for use in damp areas or outdoors



FAS No.	Type	Weight, kg
26061	Without explosion protection	0,9
26062	With explosion protection	1,0

FAS No.	Lamp	Qty. of Batteries	Weight, kg
26 161	2,5 V/0,3 A	2	0,20
26 162	3,7 V/0,3A	3	0,25



## 0

## Connecting Parts

## Seal PN 40

- LPG-proof
- DIN 2690
- asbestos-free

## Type:

- A – Universal high-pressure seal with inner rim of galvanized soft iron, 2 mm thick
- B – Soft seal of Perbunan with steel insert, DIN-DVGW-approved, reusable, 5 mm thick
- C – Graphite high-pressure seal with insert of stainless steel foil, corrugated, FIRE SAFE to BS 6755, max. 650°C, with inner rim of stainless steel, 2 mm thick
- D – Special high-pressure seal, FIRE SAFE to BS 5146, max. 650°C, with inner rim of galvanized soft iron, 2 mm thick

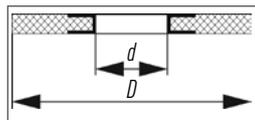

Type A, D

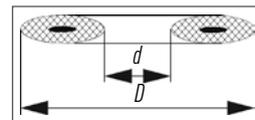

Type B

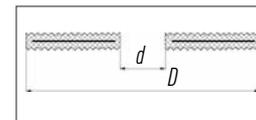

Type C

FAS No.				Size, DN	Dimensions, mm	
Type A	Type B	Type C	Type D		D	d
10 641	10 651	10 941	10 991	15	50	22
10 642	10 652	10 942	10 992	20	60	27
10 643	10 653	10 943	10 993	25	70	34
10 644	10 654	10 944	10 994	32	82	43
10 645	10 655	10 945	10 995	40	92	48
10 646	10 656	10 946	10 996	50	107	60
10 647	10 657	10 947	10 997	65	127	76
10 648	10 658	10 948	10 998	80	142	89
10 649	10 659	10 949	10 999	100	168	114
10 650	10 660	10 940	10 990	125	195	141

## Compensator

for pipelines PN 25

- DIN 2635
- with flange connection



FAS No.	DN	Weight, kg
10 751	25	2,00
10 752	32	3,20
10 753	40	3,40
10 754	50	4,75
10 755	65	6,00
10 756	80	7,50
10 757	100	10,15

## High pressure LPG hose

LPG PN 25, Type FAS

- acc. to DIN EN 1762
- temperature range:  
-30 up to +70°C
- electrically conductive



FAS No.	DN	External diameter, mm
10 801	10	20
10 800	13	23
10 802	19	31
10 803	25	37
10 804	32	44
10 805	50	66
10 806	80	93

*High-pressure hose for ammonia and other sizes are available on request*

**Straight pipe union PN 40**

- with NPT male thread
- galvanized

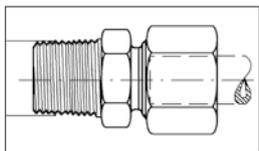

*Elbow and tee unions available on request*

FAS No.	NPT, "	Pipe O.D.	Weight, kg
10 701	1/4	8	0,04
10 702	1/4	10	0,05
10 703	1/4	12	0,06
10 704	3/8	10	0,06
10 705	3/8	12	0,07
10 706	1/2	12	0,08

FAS No.	NPT, "	Pipe O.D.	Weight, kg
10 707	1/2	15	0,11
10 708	1/2	18	0,13
10 709	1/2	22	0,16
10 710	3/4	18	0,15
10 711	3/4	22	0,18
10 712	1	28	0,21

**Insulating Flange Set PN 40**

- pre-assembled and dielectrically tested to 5 kV



*Flanges must be demounted before installation in pipelines.*

FAS No.	Size, DN	Connection D×s	Length, mm	Weight, kg
10 770	15	21,3×2,0	88	1,9
10 771	20	26,9×2,3	97	2,2
10 772	25	33,7×2,6	97	3,5
10 773	32	42,4×2,6	100	5,0
10 774	40	48,3×2,6	108	6,0
10 775	50	60,3×2,9	114	7,0
10 776	65	76,1×2,9	122	10,0
10 777	80	88,9×3,2	133	12,3
10 778	100	114,3×3,6	148	17,5

**Discharger**

explosion-proof, for bridging of insulating flanges in hazardous areas

- complete with connecting cable = 200 mm

**Complete hose connection PN 25**

- hose nipple of steel
- with clamp of aluminium
- complete mounting parts

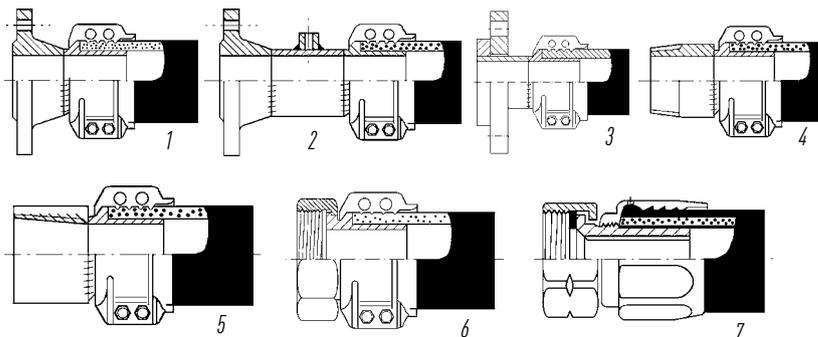

Type:

1. Flange PN 40, DIN 2635
2. Flange PN 40, DIN 2635 and half coupling PN 40, 1/2" NPT for relief valve
3. Lapped flange PN 40, DIN 2656
4. Nipple PN 40, with NPT-thread
5. Half coupling PN 40, with NPT-thread
6. Union nut (brass), flat seal
7. Union nut (brass), flat seal

FAS No.	Screw connection	Weight, kg
10 615	M12	1,1
10 616	M16	1,1
10 617	M20	1,2
10 618	M24	1,2

*Data table of hose connections – on next page*

FAS No.	Connection /LPG	Type
10 811	DN 20/19	1
10 812	DN 25/19 R	1
10 813	DN 25/25	1
10 814	DN 25/32	1
10 815	DN 32/25 R	1
10 816	DN 32/32	1
10 817	DN 40/32 R	1
10 818	DN 40/50	1
10 819	DN 50/32 R	1
10 820	DN 50/50	1
10 821	DN 50/50	2
10 822	DN 50/50	3
10 823	DN 65/50 R	1
10 824	DN 65/80	1
10 825	DN 80/50 R	1
10 826	DN 80/80	1
10 827	DN 80/80	2
10 828	DN 80/80	3
10 888	1/2" NPT/13	4

FAS No.	Connection /LPG	Type
10 831*	1/2" NPT/19	4
10 832*	3/4" NPT/19	4
10 833	3/4" NPT/25	4
10 834	1" NPT/19 R	4
10 835*	1" NPT/25	4
10 836*	1" NPT/32	4
10 837*	1 1/4" NPT/32	4
10 838	1 1/2" NPT/32	4
10 839*	2" NPT/50	4
10 840	2" NPT/80 R	4
10 841	2 1/2" NPT/50 R	4
10 842	3" NPT/50 R	4
10 843*	3" NPT/80	4
10 851	1/2" NPT/19	5
10 852	3/4" NPT/19 R	5
10 853*	3/4" NPT/25	5
10 854	1" NPT/19 R	5
10 886	G 1/2"/1 3	7
10 855	1" NPT/25 R	5

FAS No.	Connection /LPG	Type
10 844*	1" NPT/32 R	5
10 856	1 1/4" NPT/25	5
10 857	1 1/4" NPT/32 R	5
10 858	1 1/2" NPT/32 R	5
10 859	2" NPT/50	5
10 860	2" NPT/80	5
10 861	2 1/2" NPT/50 R	5
10 862	2 1/2" NPT/80	5
10 863	3" NPT/50 R	5
10 864	3" NPT/80 R	5
10 869	3/4" NPT female	like 5
10 873	G 1 1/4"/25	6
10 865	G 1 1/4"/32	6
10 850	M 65×2/50	like 6
10 849	M 100×2/80	like 6
10 866	M 30×1,5 links/19	7
10 867	W 21,8×714" links/10 7	
10 892	M 60×4/ DN 32	like 6
10 920	M 60×4/ DN 50	like 6

\* One-piece turned part without welding, galvanized

## A

## Industrial compressors

## Corken compressors for industrial applications

- type of compressors – piston
- type of cooling – air
- type of lubrication – oil free
- type of compression – single stage, two staged
- purging system (optional)
- working pressure – up to 112 bar
- capacity – up to 50000 m<sup>3</sup>/h (depending on process)



## Applications:

- transport of liquid gases
- recuperations of gases
- oil, natural gases production
- CNG applications
- loading and unloading of liquid gases
- chemical and petrochemical processes

## Common mediums

Ammonia	Cyclopropane	Hydrogen	Cyclohexan
Argon	Deuterium	Hydrogen Chloride	Hydrocarbon gas
Benzene	Dimethylamine	Isobutane	Monomethylamine
Biogas	Dimethyl ether	Isobutene	Natural gas
Butadiene	2,2-dimethylpropane	Isobutylene	Neon
Bromotrifluoromethane	Ethane	Krypton	Nitric oxide
Carbon dioxide	Ethyl chloride	Methane	Nitrous oxide
Carbon monoxide	Ethylene	Methyl acetylene	N-octaine
Carbon tetrachloride	Ethylene oxide	Methyl bromide	Ozone
Carbonyl sulfide	Helium	Methyl chloride	N-pentane
Chlorine	Hexafluoroethane	Methyl fluoride	Phosgene
Chlorodifluoro-Methane	N-heptane	Methyl mercaptane	Propane
Cyanogen	N-hexane	Monoethylamine	Propylene

## Refrigerants

CFC-11	CFC-503	Sulfur dioxide	Vinyl bromide
CFC-12	NCFC-22	Sulfur hexafluoride	Vinyl fluoride
CFC-13	NCFC-141B	Tetrafluoroethylene	Vinyl chloride
CFC-113	NCFC-134A	Trichlorethane	Xenon
CFC-502	NCFC-152A	Trimethylamine	



Model line		Single stage compressors							Two stage compressors						
		D91	D291	D491	D491-3	D691	D691-4	D891(a)	FD151	D191	FD351	D391	D590	FD591	D791(a)
Cylinder diameter, mm	1 stage	1 cylinder	76,2	101,6	76,2	114,3	101,6	114,3	63,5	76,2	69,9	114,3	152,4	152,4	152,4
	2 stage	76,2							31,8	44,5	44,5	63,5	82,5	82,5	82,5
Piston stroke, mm		63,5	63,5	76,2	76,2	101,6	101,6	101,6	63,5	63,5	76,2	76,2	101,6	101,6	101,6
Capacity, m <sup>3</sup> /h:															
Min. at 400 U/min <sup>-1</sup>		6,8	13,6	29,2	16,7	49,6	39,4	96,2	79	6,8	117	18,8	30,9	30,9	87,0
Max. at 825 U/min <sup>-1</sup>		14,1	25,4	60,3	34,3	102,3	81,6	192,4	164	14	14,4	38,7	63,7	63,7	179,6
Max. operation pressure, bar		24,1	24,1	24,1	42,4	24,1	42,4	32,1	82,8	42,4	82,8	43,1	24,1	42,4	42,4
Max. power consumption, kW		5,6	11	11	11	26,1	26,1	34	11	11	11	11	34	26,1	34
Max. piston rod load, kg		1633	1633	1814	1814	2495	3175	3175	1633	1633	1814	1814	3175	3175	3175
Max. outlet temperature, °C		177	177	177	177	177	177	177	177	177	177	177	177	177	177
Double gland T-style (optional)		•	•	•	•	•	•			•		•		•	
Flanges ANSI/DIN (optional)		•	•	•	•	•	•		•	•	•	•		•	
Water cooling (optional)						•	•				•	•	•	•	

**Horizontal industrial compressors**

- up to 4-stage version
- max. pressure – 310 bar
- max. displacement/capacity >600 m<sup>3</sup>/h
- piston stroke – 76,2 mm
- max. piston rod strain – 3175,2 kgs
- max. motor capacity – 58 kW
- max. outlet temperature – 176,7°C
- speed range – 400...1200 U/min<sup>-1</sup>



Two stage model	HG602AB	HG602AD	HG602BD	HG602BE	HG602DE	HG602DF	HG602EF
Cylinder diameter, inch	8×6	8×4	6×4	6×3,25	4×3,25	4×2,75	3,25×2,75
Capacity (1200 min <sup>-1</sup> ), m <sup>3</sup> /h	351,7	351,7	195,4	195,4	84,6	84,6	54,5
Weight, kg	430,0	423,2	386,9	380,1	373,3	373,3	364,2
Water cooling (optional)	WG602AB	WG602AD	WG602BD	WG602BE	WG602DE	-	-
Single stage model	HG601AX	HG601BX	HG601CX	HG601DX	HG601EX	HG601FX	HG601AA
Cylinder diameter, inch	8	6	5	4	3,25	2,75	8×8
Capacity (1200 min <sup>-1</sup> ), m <sup>3</sup> /h	351,7	195,4	134,4	84,6	54,5	56,0	703,5
Weight, kg	423,2	393,7	390,5	373,3	364,2	364,2	456,8
Water cooling (optional)	WG601AX	WG601BX	-	WG601DX	WG601EX	-	WG601AA
Cylinder bore, mm	203,2	203,2	152,4	152,4	127	127	101,6
Max. operation pressure, bar	21,7	21,7	25,2	25,2	51,7	51,7	70,0

**Dry running piston compressor unit for ammonia (NH<sub>3</sub>)**

- technical process for a chemical facility
- combined 1- and 2-staged execution
- automated change over in 2-staged execution
- application of control equipment with AUMA-drives
- heat exchanger as an intercooler
- complete pipe system, liquid trap, pulsation damper
- instrumentation and monitoring of operation process
- suitable for location outside and inside, installation in Ex-Zone II

**Technical data**

Inlet pressure min.	0,5 bar
Inlet pressure max.	21 bar
Cubic capacity	1-staged operation – 302,8 m <sup>3</sup> /h
	2-staged operation – 179,4 m <sup>3</sup> /h
Motor capacity	58 kW
Weight	2650 kg

**Dry running piston compressor unit for propylene**

- rail tanker unloading station
- medium: Propylene
- 1-stage design
- complete pipe line system
- liquid trap
- instrumentation and monitoring of operation process
- suitable for location outside and inside
- suitable for installation in Ex-Zone II

**Technical data**

Inlet pressure min.	0,5 bar
Inlet pressure max.	19 bar
Cubic capacity	393 Nm <sup>3</sup> /h
Motor capacity	58 kW
Weight	2289 kg



**Dry running piston compressor unit for Hexane**

- technical process for a chemical facility
- 2-staged execution
- heat exchanger as an intercooler
- controlling of frequency converters
- complete pipe system
- instrumentation and monitoring of operation process
- suitable for location outside and inside, installation in Ex-Zone II

**Technical data**

Inlet pressure min.	0,5 bar
Inlet pressure max.	25 bar
Cubic capacity	13 Nm <sup>3</sup> /h
Motor capacity	5,5 kW
Weight	460 kg

**Dry running piston compressor unit for Nitrogen (N<sub>2</sub>)**

- technical process for fertilizer facility
- 2 compressors, 2 process lines
- surge drum acc. To ASME with isolation
- 2-staged compressor FD351
- heat exchanger as an intercooler
- complete pipe system acc. To ASME 31.3
- medium contacting parts from stainless steel
- instrumentation and monitoring of operation process
- fittings from ASME
- instrumentation with UL/FM
- suitable for location inside
- suitable for installation in Ex-Zone II

**Technical data**

Inlet pressure min.	5 bar
Inlet pressure max.	58 bar
Cubic capacity	1-staged – 9,6 Nm <sup>3</sup> /h / 2-staged – 3,9 Nm <sup>3</sup> /h
Motor capacity	2×7,4 kW
Weight	3476 kg





## B

## Industrial pumps

**Universal single-stage circulation pump  
in a compact block version BLOC NUB/NUBF**

## High power efficiency

- low flow rate
- slight speed-high difference

## Technical advantages

- thrust free open or balanced closed impellers
- compensation of radial force through control equipment in ring housing

## Process reliability

- partial gas transfer
- wide characteristic curves
- selection between flat or abrupt characteristic curves
- top control mode

## Easy installation

- large flange nominal sizes
- no pipe extension required
- any installation position
- compact pump design

## Easy service and operation conditions

- operating pressure up to 10 bar
- temperature -40°C up to +140°C
- viscosity up to 115 mm<sup>2</sup>/s

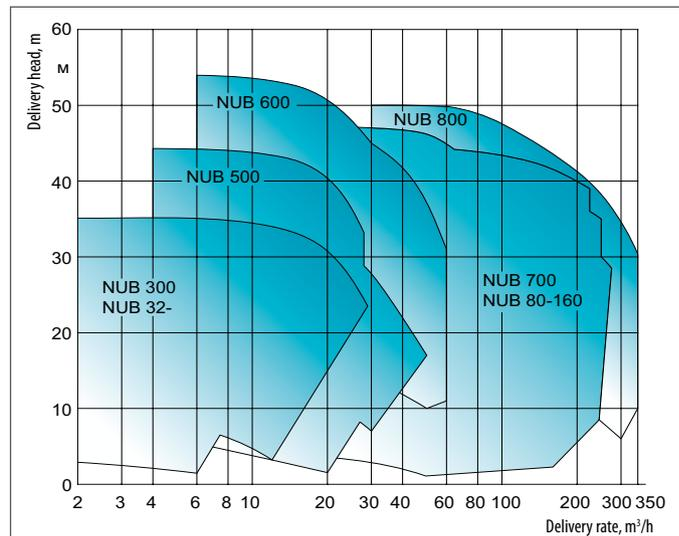

### Universal single-stage centrifugal pump BLOC CB BC in stainless steel

- closed impellers
- single or double mechanical seal
- easy service thanks to pull-back version
- material stainless steel/stainless steel sheet
- operating pressure up to 10 bar
- temperature -25 up to +110°C
- viscosity up to 115 mm<sup>2</sup>/s

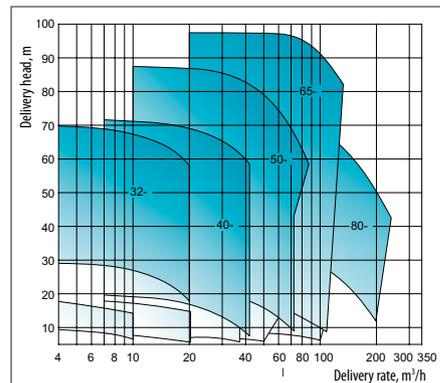

### Universal single-stage circulation pump in inline-version LUB

#### Technical advantages

- thrust free open or balanced closed impellers
- compensation of radial force through control equipment in ring housing

#### Process reliability

- capability of transfer of gas in the liquid
- wide characteristic curves
- selection between flat or abrupt characteristic curves
- top control mode

#### Easy installation and service

- pull-back version
- extracting coupling

#### Application

- operating pressure up to 10 bar
- temperature -40°C up to +140°C
- viscosity up to 115 mm<sup>2</sup>/s

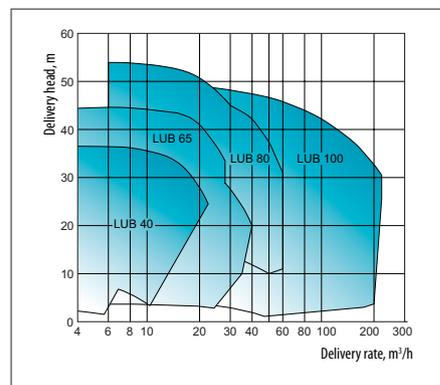

## Unchokable pump in a compact block version FUB CBF

### Process reliability

- solid transfer
- cavitation adaptability
- mild medium transfer
- non-sensitive for pigtail- and clew formation

### Technical advantages

- pulse transmission by recessed vortex type impeller
- free ball pass up to 80 mm diameter
- abrasion cover and other special designs

### Easy installation

- any installation position
- compact pump design

### Easy service

- pull-back version
- robust construction

### Application

- operating pressure up to 10 bar
- temperature -40°C up to +140°C
- viscosity up to 60 mm<sup>2</sup>/s
- solids content

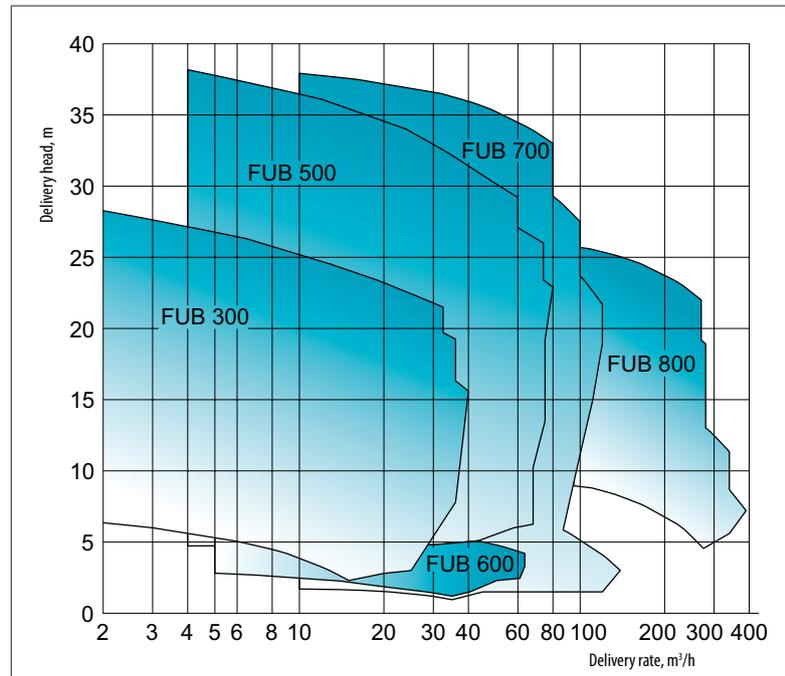

**Multi-stage circulation pump LBU VBU NHP Z**

## High power efficiency

- integrated jet pump or mixture formation
- low flow rate
- optimized impeller inflow
- small internal friction losses
- optimized stage's delivery head

## Technical advantages

- thrust free open or balanced closed impellers
- compensation of radial force through control equipment in ring housing
- NPSH-pre-stages

## Process reliability

- capability of transfer of gas in the liquid
- wide characteristic curves
- selection between flat or abrupt characteristic curves
- top control mode

## Easy installation

- modular system for individual solutions
- free selection of nipple position
- horizontal or vertical execution
- block- or ground plate design

## Application

- operating pressure up to 64 bar
- temperature  $-60^{\circ}\text{C}$  up to  $+220^{\circ}\text{C}$
- viscosity up to  $115\text{ mm}^2/\text{s}$

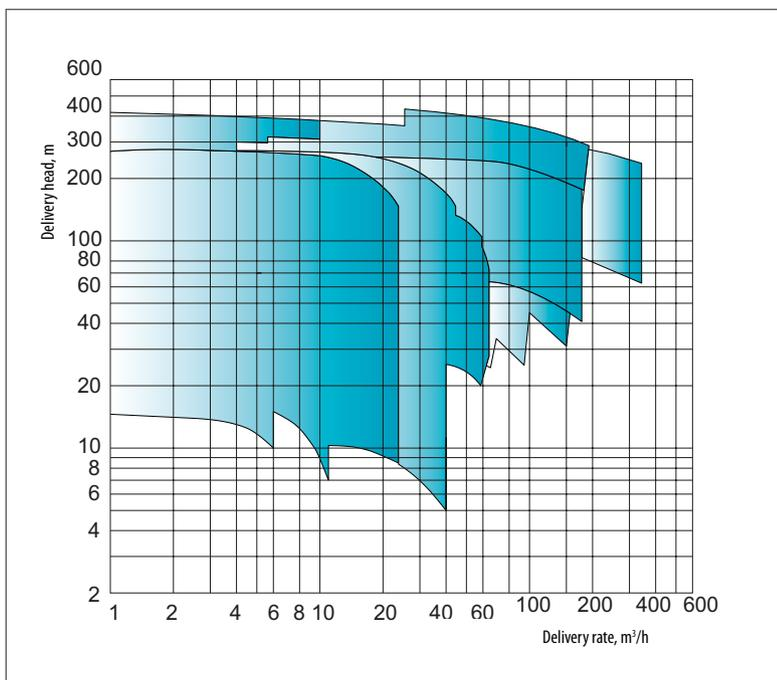

## Self-sucking centrifugal pump E SUB S

### High power efficiency

- integrated jet pump or mixture formation
- low flow rate
- optimized impeller inflow
- small internal friction losses
- optimized stage's delivery head

### Technical advantages

- thrust free open or balanced closed impellers
- compensation of radial force through control equipment in ring housing

### Process reliability

- self-sucking
- capability of transfer of gas in the liquid
- wide characteristic curves
- selection between flat or abrupt characteristic curves

### Easy installation

- modular system for individual solutions
- horizontal execution
- block- or ground plate design

### Application

- operating pressure up to 16 bar
- temperature -40°C up to +90°C
- viscosity up to 115 mm<sup>2</sup>/s

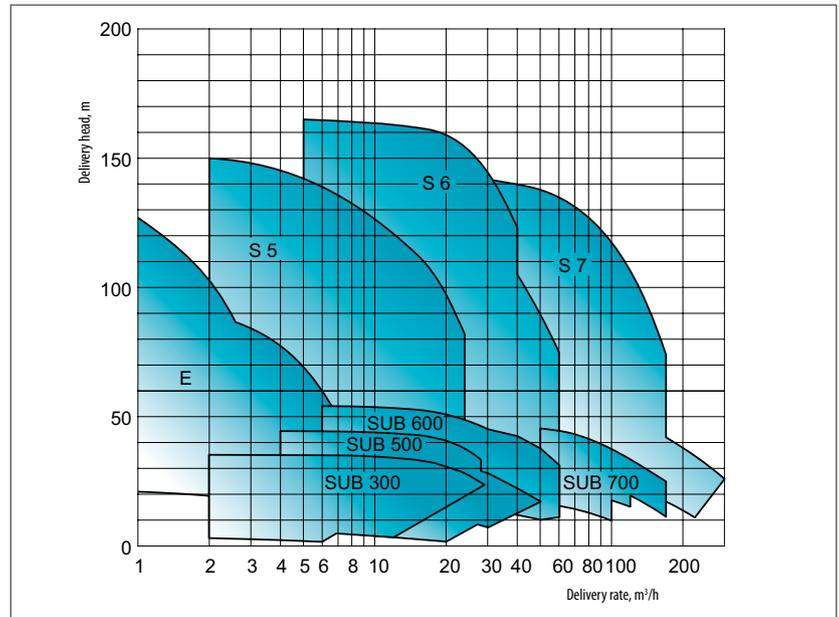

**Multiphase centrifugal pump type PBU EB LBU**

## High power efficiency

- optimal enrichment and mixing of fluids with gases
- high degree of dispersion
- low flow rate
- optimized impeller inflow
- small internal friction losses
- optimized stage's delivery head

## Technical advantages

- thrust free open impellers
- compensation of radial force through control equipment in ring housing
- direct gas addition acc. to VDMA 24430

## Process reliability

- ability of gas transfer up to 30%
- stable producing of micro bubbles

## Easy installation

- modular system for individual solutions
- horizontal execution
- block- or ground plate design

## Application

- operating pressure up to 40 bar
- temperature  $-40^{\circ}\text{C}$  up to  $+140^{\circ}\text{C}$
- viscosity up to  $115\text{ mm}^2/\text{s}$

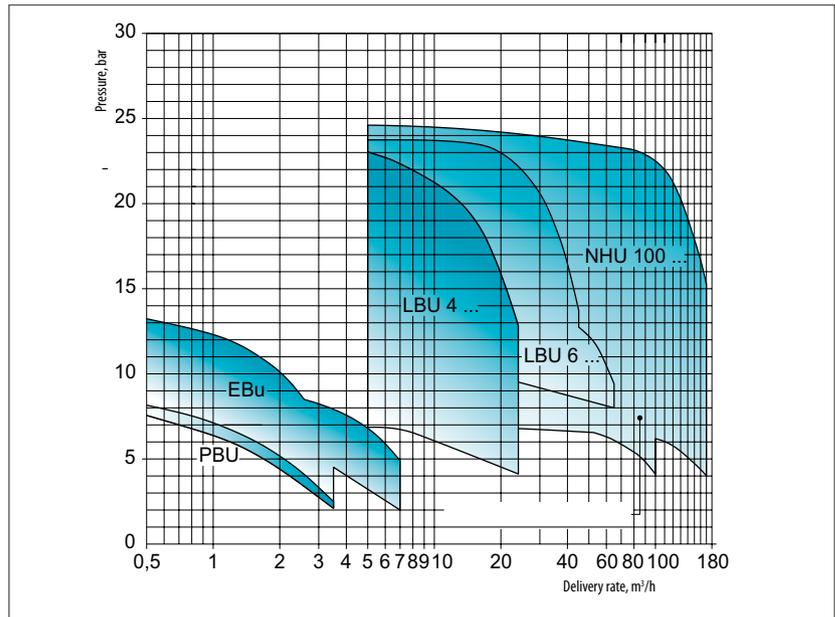

### Universal space saving submersible pump B CTOL

High power efficiency

- no shaft seal
- no external leakage
- with vortex type impeller

Easy installation

- space saving design
- modular system for individual solutions

Applications

- operating pressure up to 10 bar
- temperature -25 up to +90°C
- viscosity up to 115 mm<sup>2</sup>/s
- special pump models for other conditions

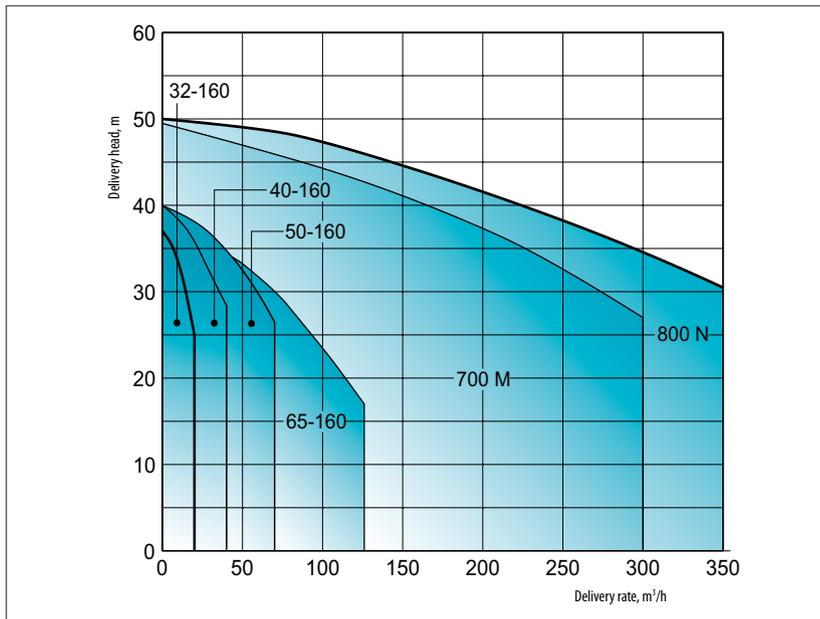

### Pump unit for transfer of light fuel oil products (petrol, kerosene, diesel and fuel oil)

- constant high efficiency
- ability to increase the productivity and differential pressure
- mechanical seal
- available with double mechanical seal "Tandem" or magnetic coupling
- compact version



Einfach wirkende Gleitringdichtung

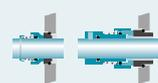

Doppelt wirkende Gleitringdichtung

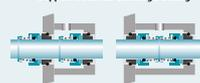

Magnetkupplung



FAS No.	Pump type	Delivery rate m <sup>3</sup> /h (l/min)	Delivery head (NPSH), m (bar)	Max. pressure, bar	Inlet/Outlet	Motor capacity, kW	Weight, kg
46 0301	NZ-3-6-2,5	3 (50)	66 (5,5)	16,0	65/40 (PN16/PN40)	2,5 (T3)	70
46 0302	NZ-6-7-3,3	6 (100)	79 (6,5)	16,0		3,3 (T3)	100
46 0303	NZ-12-7-5,5	12 (200)	80,5 (6,7)	16,0		5,5 (T3)	100
46 0304	NZ-18-6-5,5	18 (300)	68 (5,6)	16,0		5,5 (T3)	100
46 0305	NZ-30-6-10	30 (500)	71,5 (5,9)	16,0	80/65 (PN16/PN40)	10,0 (T3)	162
46 0306	NZ-42-6-12,5	42 (700)	69 (5,7)	16,0		12,5 (T3)	171
46 0307	NZ-60-6-15	60 (1000)	64 (5,3)	40,0	125/100 (PN40)	15,0 (T3)	281
46 0308	NZ-90-6-24	90 (1500)	65 (5,4)	40,0		24,0 (T3)	370
46 0309	NZ-150-6-36	150 (2500)	72 (5,9)	40,0		36,0 (T3)	395
46 0310	NZ-180-7-68	180 (3000)	87,5 (7,2)	40,0	200/125 (PN40)	68,0 (T3)	1100

### Pumps Corken type PT

for petroleum products and industrial solvents (gasoline, fuel oil, diesel fuel, ethanol, solvents)

FAS No.	Type	Connection, " NPT	Max. capacity, l/ min	Max. operation pressure, bar	Max. differential pressure, bar	Max. operation temperature, °C
21 2963	PT 20	2	340	13,8	8,6	149
21 2962	PT 25	2½	610	13,8	8,6	149
21 2961	PT 30	3	1030	13,8	8,6	149





## C

## Industrial measurements

**Mass flow meters FAS 98 8687 Promass F 300, 8F3B50**

- for liquid CO<sub>2</sub>
- connections – DN 50 2"
- operation pressure – 8 bar
- maximum flow rate – 50000 kg/h

**Mass flow meters FAS 98 8686 Promass F 300, 8F3B80**

- for liquid CO<sub>2</sub>
- connections – DN 80 3"
- operation pressure – 8 bar
- maximum flow rate – 120000 kg/h

*Other flow rates on request*

**Complete measuring unit Type LC for petroleum**

FAS No.	Type	Connection	Max. capacity, l/min	Execution
98 1665	LC M7CX0100	2"	500*	VR register/excl. printer
98 1666	LC M15CX0100	3"	1000*	
98 1667	LC M25CX0100	3"	1150*	
98 1668	LC M30CX0100	4"	1700*	

FAS No.	Type	Connection	Max. capacity, l/min	Execution
98 1660	LC M7GX0100	2"	500*	VR register/incl. mech. printer
98 1661	LC M15GX0100	3"	1000*	
98 1662	LC M25CX0100	3"	1150*	
98 1663	LC M30CX0100	4"	1700*	

FAS No.	Type	Connection	Max. capacity, l/min	Execution
98 1670	LC M7-TEX	2"	500*	TEX register/excl. printer (FAS No. 38466 Epson Slip printer TM-U295 is by request available)
98 1671	LC M15-TEX	3"	1000*	
98 1672	LC M25-TEX	3"	1150*	
98 1673	LC M30-TEX	4"	1700*	

\* capacity depends on viscosity

# D Road tanker equipment

## FAS 32 0451 Corken pump for liquid CO<sub>2</sub>, Type CDBN 1022

- inlet /outlet – 3" NPT
- flow rate (max) – 1514 l/min (by low viscosity medium)
- maximum differential pressure – 8,6 bar
- high pressure design with O-ring construction
- mechanically sealed with a silicon carbide seal seat
- six vanes and vane drivers
- adjustable internal relief valve
- replaceable cam, liner, and reversible slide plates
- ideal for liquids with high vapor pressures



## Pumps Corken PZ

for petroleum products and industrial solvents, for installation on a road tanker

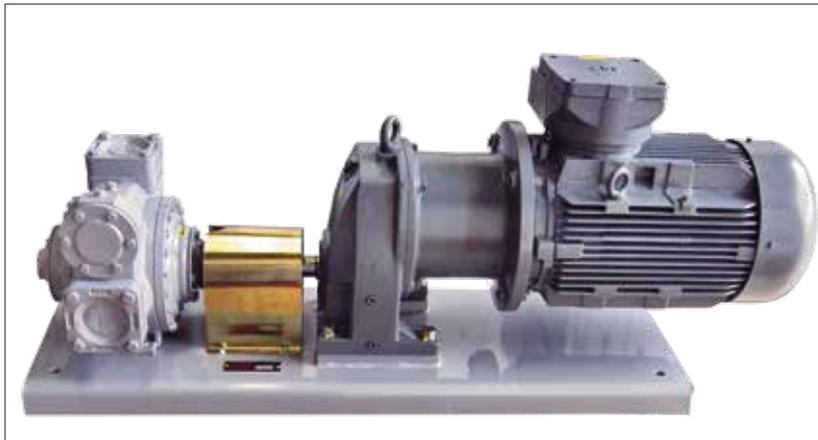

## FAS 21 3181 FAS-Corken pump aggregate for liquid CO<sub>2</sub>

Type CDBN 1022, capacity approx. – 530 l/min at 2 bar differential pressure; 450 l/min. at 8,6 bar differential pressure. Consists of:

- pump CDBN 1022, connection – 3" NPT, with special mechanical seal,
- gear-motor 7,5 kW (560 rpm, IP 54, 400/690 V)
- with coupling and coupling protection
- mounted on a common base plate

## FAS-Corken pump aggregate for liquid CO<sub>2</sub>

Type CDBN 1022, capacity approx. – 530 l/min at 2 bar differential pressure; 450 l/min. at 8,6 bar differential pressure.

### Execution:

- **FAS 21 3183** – without ground plate
- **FAS 21 3182** – standart

FAS-Corken pump aggregate consists of:

- pump CDBN 1022, connection – 3" NPT, with special mechanical seal,
- gear-motor 15,0 kW (560 rpm, IP 54, 400/690 V)
- with coupling and coupling protection
- mounted on a common base plate

FAS No.	Type	Connection, " NPT	Max. capacity, l/min	Max. operation pressure, bar	Max. differential pressure, bar	Max. operation temperature, C°
21 2966	PZ 7	2	400	13,8	8,6	149
21 2969	PZ 10	2½	610	13,8	8,6	149



### FAS 21 284 Blackmer-pump for liquid CO<sub>2</sub>

Type CRL3

- inlet/outlet – 3" NPT,
- maximum flow rate – 560 l/min (by low viscosity medium)
- maximum differential pressure – 8,6 bar
- double wave version



### FAS 21 288 FAS-Blackmer pump aggregate for liquid CO<sub>2</sub>

Type CRL3. Capacity approx. – 400 l/min at 3 bar differential pressure, 320 l/min at 6.5 bar differential pressure. Pump aggregate consisting of:

- pump CRL3, connection – 3" NPT, with special mechanical seal
- with gear-motor 7,5 kW, 570 rpm, IP 54, 400/690 V
- with coupling and coupling protection
- mounted on a common base plate

### FAS 21 285 Blackmer-pump for liquid CO<sub>2</sub>

Type CRL4

- inlet/outlet – 4" NPT,
- maximum flow rate – 950 l/min (by low viscosity medium)
- maximum differential pressure – 8,6 bar
- right hand rotation

### FAS 21 2882 FAS-Blackmer pump aggregate for liquid CO<sub>2</sub>

Type CRL3. Capacity approx. – 400 l/min at 3 bar differential pressure, 320 l/min at 6.5 bar differential pressure. Execution – without ground plate. Pump aggregate consisting of:

- pump CRL3, connection – 3" NPT, with special mechanical seal
- with gear-motor 7,5 kW, 570 rpm, IP 54, 400/690 V
- with coupling and coupling protection
- without common base plate



### Centrifugal pump unit for CO<sub>2</sub> liquid phase

- type – NZ 36-7,4-15 STW
- normal suction
- horizontal
- bloc design
- with electromotor
- material – stainless steel V4A

FAS No.	Motor, kW	Capacity, l/min	By dif. pressure, bar	P <sub>max</sub> , bar
46 0963	15	600	6,6 (1,03 dm/cm <sup>3</sup> ) 7,5 (1,116 dm/cm <sup>3</sup> )	40
46 0967	Bare pump	750 max	–	40

A

## Refueling stations LNG, L-CNG

Through many years of experience in the liquid gas market FAS has already been involved several times in the construction of gas refueling. With our wide range of various filling station executions, we can find the right solution for every application. The rapid development of natural gas applications (NG) has moved us to extend our know-how for LNG and L-CNG filling stations.



### LNG filling station – Version 1: LNG

LNG filling stations FAS are designed for filling of all types of trucks with liquefied natural gas. Typical filling station consists of the following components:

- LNG tank
- pump unit of low pressure
- saturation vaporizer
- LNG dispenser
- electrical control box

*The module design allows in the shortest possible time to adapt the performance of the station to almost any consumer needs.*



### LNG filling station – Version 2: a combination of LNG-L-CNG

Combined filling stations FAS are designed for filling of all cars with liquefied natural gas and liquefied compressed natural gas. Typical filling station consists of following components:

- LNG tank
- pump unit of low pressure (LNG line)
- saturation vaporizer (LNG line)
- LNG dispenser (LNG line)
- pump unit of high pressure (L-CNG line)
- high pressure vaporizer (L-CNG line)
- block-battery (LNG line)
- LNG dispenser (LNG line)
- electrical control box

*The module design allows in the shortest possible time to adapt the performance of the station to almost any consumer needs.*



### LNG filling station – Version 3: modular LNG filling station in container execution

LNG filling station in container execution is designed to carry out the following processes:

- receipt and storage of LNG
- increase of LNG pressure up to 5-8 bar
- filling of LNG trucks

The station is a factory product ready for connection and includes all the main components for safe reception, storage and refueling with automatic control of all production processes.

Container design suppose a limitation of the volume of capacity to 20 cubic meters. If necessary, to increase the storage volume – it is possible to carry out the tank outside the container.



## B

## Regasification unit



## Regasification stations in their standard executions

The LNG regasification station is designed to convert the liquid phase into vapor, followed by lowering the pressure incl. odorizing option for further supply to various groups of natural gas consumers.

The most demanded standard sizes of LNG regasification stations are

Consumption LNG, kg/h	Capacity, kW/h	Capacity of vaporizer, Nm <sup>3</sup> /h	Area of vaporizer, m <sup>2</sup>
100	1 200	150	64
170	2 000	300	121
330	4 000	450	178
500	6 000	750	300
650	8 500	900	355
750	9 500	1 050	390
1 000	12 500	1 500	586
2 000	25 000	2×1500	2×586

Regasification stations consist of the following main technological units

Tank	Vaporizer	Vaporizer	Heating	Regulator	Metering unit	Odorizer	Automation
Unit 1	Unit 2	Unit 3	Unit 4	Unit 5	Unit 6	Unit 7	Unit 8

Installations of higher capacity are possible. The volume and number of containers depends on required capacity and delivery frequency.

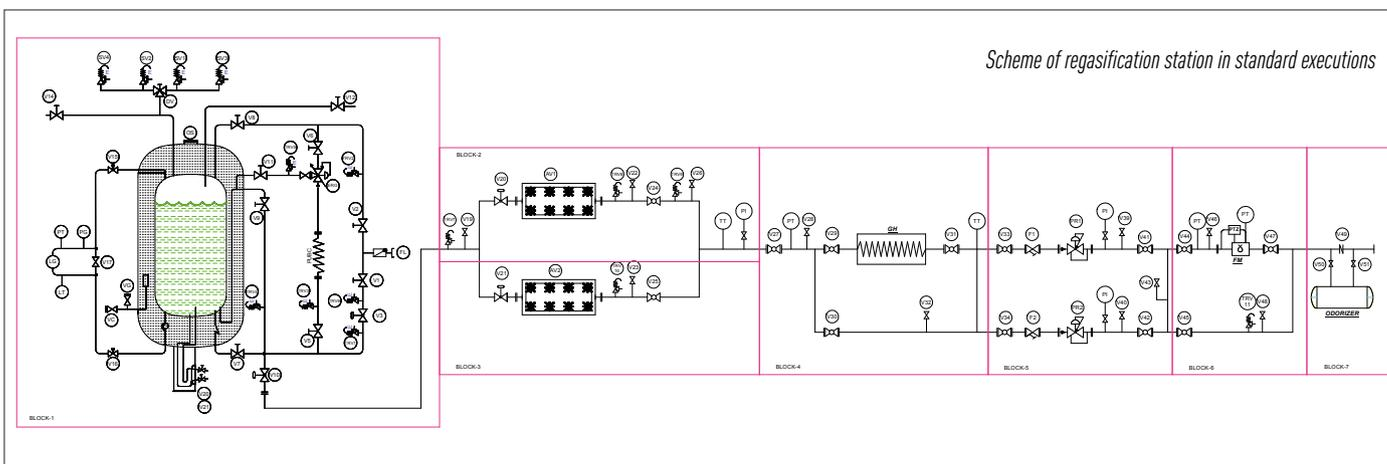



### Regasification stations in container design

The LNG regasification station is designed to convert the liquid phase into vapor, followed by lowering the pressure incl. odorizing option for further supply to various groups of natural gas consumers.

The most demanded standard sizes of LNG / LNG regasification stations are

Dimensions of tank frame	Capacity	Capacity of vaporizer, Nm <sup>3</sup> /h	Area of vaporizer, m <sup>2</sup>
10 ft	1 500	150	66
20 ft	4 000	450	178
30 ft	7 000	800	289
40 ft	10 000	1 150	445

Regasification stations in container design consist of following units:

Tank	Vaporizer	Vaporizer	Heating	Regulator	Metering unit	Odorizer	Automation
Unit 1	Unit 2	Unit 3	Unit 4	Unit 5	Unit 6	Unit 7	Unit 8

As a tank or logistics fleet can be used the following tank containers:

- 20 ft
- 30 ft
- 40 ft

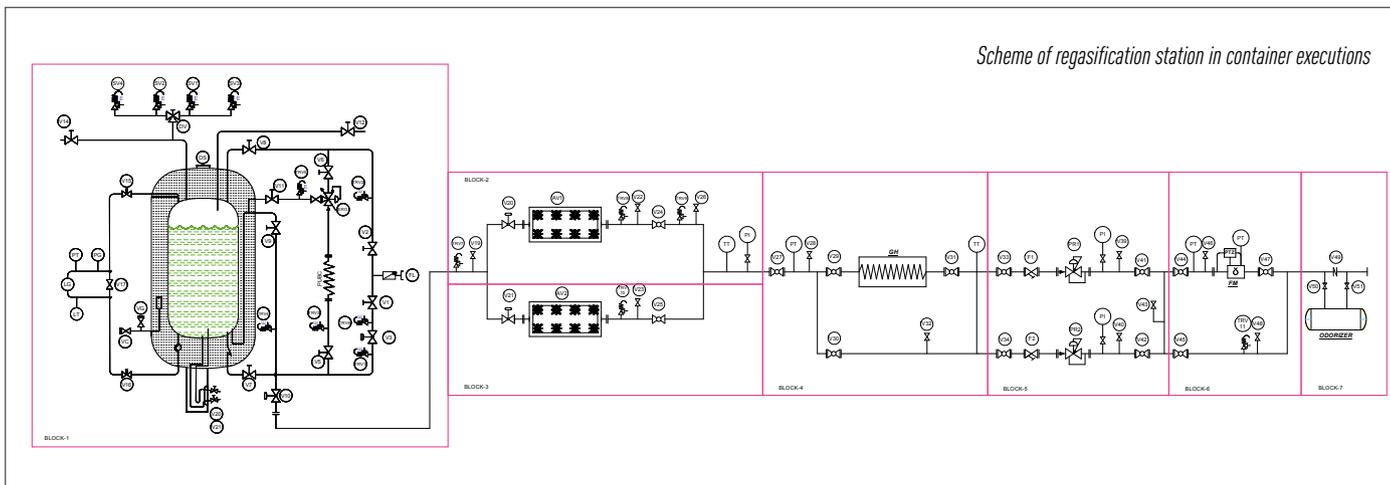

Scheme of regasification station in container executions

# C DME Dispensers and refuelling

## DME refuelling – complete plants for public and internal applications

DME fuel dispenser type FAS in design according to customer specifications, complete with an above-ground storage up to 4,850 l and all necessary fittings/equipment, mounted on a galvanised base frame, piped, wired, primed and painted.

### Documentation:

- with declaration of conformity and CE-marking (CE 2266) according to PED 2014/68/EU, rating according to category IV module H1

### Structural and operational features

- overfill protection, type CL or comparable. Optionally with or without level measurement
- filling line for the tank is equipped with ball valve, solenoid valve, non-return valves (2 pcs.)
- solenoid valve explosion proof DN 25 PN 40, 230 V, 50 Hz
- Ebsray pump unit type RC 25 for DME, PN 25 (flow rate: max. 90 l/min at 2990 rpm, 3-phase)
- motor 2,5 kW, EEx e II T3, 400/690V, 50 Hz)

### DME Fuel dispensers type FAS

with full hose system were specially developed for dispensing of DME. The advantages include modern design, low maintenance costs, long service life, high performance, reliability and safety with a good price-performance ratio. DME dispensers from FAS are available in various designs for public and internal use.

### Electrical equipment

- electronic price calculator
- LCD-Display
- protocol according to customer specifications
- power supply – 230 V AC/50-60 Hz.

### Hydraulic equipment

- PN 25 design
- special Coriolis meter for DME
- gas bubble separator

- pressure retaining valve
- hydraulic accumulator
- pipe-break valve upstream of DME hose
- DME high pressure hose
- pressure line connection: 1" NPT female
- vapour recovery line connection: ¾" NPT female
- DME dispensers for public use are MID compliant

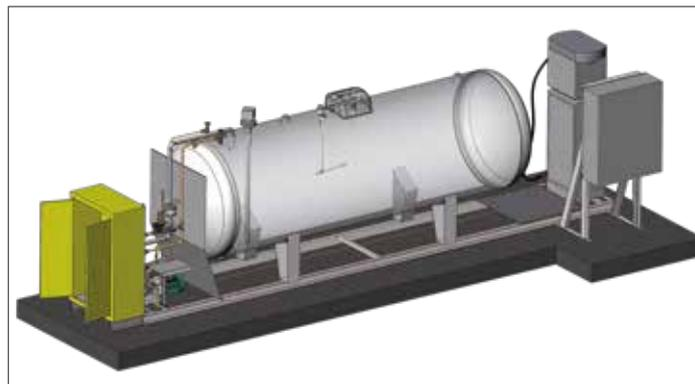

- relief valve, type RV18-CBS10 (vapour removal system), 1" NPT female, with recirculation into the gas phase of the tank
- dry-running protection by means of electrical power measurement
- with break away coupling in the pressure line of the delivery device
- including galvanised fire protection plate for isolation of the tank connection fittings.

### Dispensers types:

- FAS-120: 1 meter, 1 high pressure hose, 1 display
- FAS-220: 1 meter, 1 high pressure hose, 1 display, housing „High Mast“
- FAS-230: 2 meter, 2 high pressure hoses, 2 displays, housing „High Mast“
- FAS-430: in-plant use, 1 meter, 1 high pressure hose, 1 display



**Options:** Foundation frame, galvanized, for screwing on or setting in concrete; Foundation frame, galvanised, to accommodate breakaway couplings; Solenoid valve in the pressure line; Hose retraction system.





## LNG-Tanks

### LNG tanks

LNG tanks are available both in a vertical and in a horizontal execution. Tank design depends on the purpose and intended use:

- as a part of a filling station
- as a part of the regasification station

The time of non-drainage storage is determined by the maximum working pressure and type of insulation.

V, liter	Dif.	Net V, liter	Working pressure, bar	Height, mm	Diameter, mm	Length, mm	Weight, kg (5 bar)	Weight, kg (12 bar)
5 800	5%	5 500	5-12	2 300	2 300	4 200	2 400	2 700
8 000		7 700				5 200	2 800	3 200
10 300		9 800				6 200	3 200	3 600
15 900		15 100				8 200	4 200	4 900
20 400		19 500				10 700	5 000	5 900
22 700		21 500		11 700	5 500	6 400		
32 100		30 100		3 000	3 000	9 500	7 500	8 500
42 400		40 300				12 000	9 300	10 600
52 700		50 100				14 500	11 100	12 700
67 300		63 900		3 700	3 700	12 700	12 900	15 300
76 500	72 700	14 200	14 100			17 000		

Tanks with volume up to 200 m<sup>3</sup> available on request

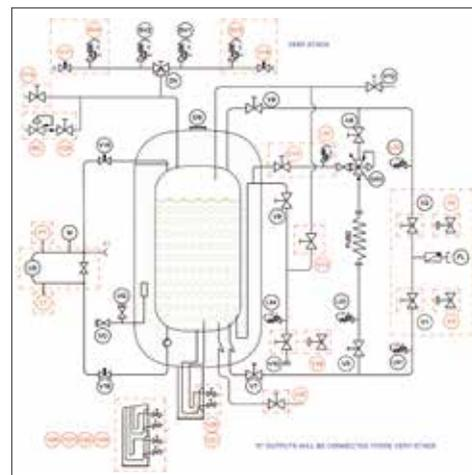

Hydraulic scheme  
of LNG tank

## E

# Road tanker equipment

## Cryogenic centrifugal pump applications:

- road trailers unloading, storage/iso-containers loading/ unloading
- process and back-up operations, petrochemical industry applications
- special applications with differential head and flow-rates upon customer demand

## Cryogenic centrifugal pump unit SGM 185 for LNG

FAS No. – 96 624, maximum capacity – 550 l/min (by maximum differential pressure 6 bar), electric motor – 11 kW (50 Hz 400 V, ATEX Ex-D IIB T4) with junction box and gearbox transmission. Type of shaft-seal – rulon mechanical seal. Inducer to minimize required NPSH

### Technical features

- low noise emission (< 80 dB)
- maximum allowable working pressure (MAWP) – 23/33 bar
- max head (50 Hz) – 420 m
- max suction pressure required – 6 bar
- inlet – DN 65, outlet – DN 40

### Components:

- FAS 96 6245 – PT100 temperature probe for leakage detection
- FAS 96 6246 – PT100 temperature probe – for cool-down of pump

- FAS 96 6247 – PT100 temperature probe – for over-temperature detection
- FAS 96 6240 – conical filter DN 65, assembled on the pump
- FAS 96 6241 – suction flange DN 65 PN 40, assembled on the pump
- FAS 96 6242 – discharge counter flange DN 40 PN 40 with hole G $\frac{1}{8}$ " xPT 100, assembled on the pump
- FAS 96 6243 – flexible pipe 2 $\frac{1}{2}$ " DN 65 PN 25, L=300 mm (suction line), assembled on the pump
- FAS 96 6244 – flexible pipe 1 $\frac{1}{2}$ " DN 40 PN 40, L=300 mm (discharge line), assembled on the pump

## Cryogenic centrifugal pump unit DSM 230 for LNG

FAS No. – 96 626, capacity – 1000 l/min (by max differential pressure 3 bar), motor 11 kW (50 Hz 400 V, ATEX Ex-D IIB T4), with junction box and Direct Coupling transmission. Type of shaft-seal – rulon mechanical seal. Inducer to minimize required NPSH.

### Technical features

- low noise emission (< 80 dB)
- transmission – Direct Coupling
- max suction pressure required – 6 bar
- inlet – DN 100, outlet – DN 80

### Components:

- FAS 96 6261 – conical filter DN 100, assembled on the pump
- FAS 96 6262 – flange ASME B16.5 type SO-RF 4" -300 LB A304, assembled on the pump
- FAS 96 6263 – flange ASME B16.5 type SO-RF 3" -300 LB A30, assembled on the pump

- FAS 96 6264 – flexible pipe 4" DN 100 PN 25, L=300 mm, assembled on the pump
- FAS 96 6265 – flexible pipe 3" DN 80 PN 25, L=275 mm, assembled on the pump
- FAS 96 6266 – PT 100 temperature probe for leakage detection
- FAS 96 6267 – PT temperature probe for cool-down of pump

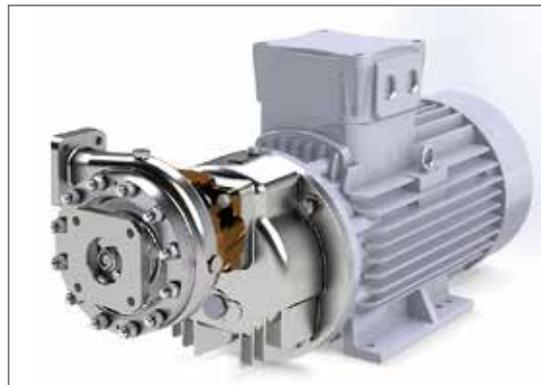

## Coriolis flow meters for LNG mobile (road tanker) and stationary (loading of refueling and regasification stations) applications

### FAS 98 8684 LNG coriolis mass flow meter Type F500 8F5B50, 2"/DN 50

Maximum flow – 20 000 kg/h (by 2 bar operation pressure), display: mass flow unit – "kg/h", volume flow unit – "l/h", density unit – "kg/l", temperature unit – "°C".

- approval; transmitter; sensor – EAC; Z1/Z1,Ex de; Z0/1,Z21,IIC/IIIC
- D Power Supply – 24 V (DC)
- MA Output; Input 1 – Modbus RS 485
- A Output; Input 2 – w/o; input 3 – w/o; input 4 – w/o;
- F Display: operation – 4-line illum., touch control

### FAS 98 8688 LNG coriolis mass flow meter Type F500 8F5B80, 3"/DN 80

Maximum flow – 50000 kg/h (by 2 bar operation pressure), display: mass flow unit – "kg/h", volume flow unit – "l/h", density unit – "kg/l", temperature unit – "°C".

- approval; transmitter; sensor – EAC; Z1/Z1,Ex de; Z0/1,Z21,IIC/IIIC
- D Power Supply – 24 V (DC)
- MA Output; Input 1 – Modbus RS 485
- A Output; Input 2 – w/o; input 3 – w/o; input 4 – w/o;
- F Display: operation – 4-line illum., touch control



F

## Cryogenic equipment

REGO®



NEW! PRESSURE RELIEF VALVES  
NG9000 SERIES



SHUT-OFF VALVE  
T9450 SERIES



NEW! EXCESS FLOW VALVE  
NG303 SERIES



NEW! LNG RECEPTACLE  
MFR100 SERIES



GAS PHASE REGULATOR  
T734NG SERIES



NEW! QUICK  
DISCONNECT VENT  
MQD100 SERIES



PRESSURE RELIEF VALVES  
9400 SERIES



NEW! PRESSURE  
BUILDER REGULATOR  
RG SERIES



NEW! ECONOMICIZER  
ECL SERIES



NEW! IN LINE  
CHECK VALVES  
NG300 SERIES



SHUT-OFF VALVE  
T9460 SERIES



# REGO



# REGO Repair kits for LNG dispensers

Description	FAS No.	REGO No.	Application
Filling clamp CRYOMAC3-50M	61 6508	CRYOMAC3-50M	LNG fuel dispenser
Quick-release clamp for return line	61 6507	REGO 13785	LNG fuel dispenser
Breakaway coupling REGO 1" for the filling line *LIQUID*	61 9534	REGO 13740-2	LNG fuel dispenser
Breakaway coupling REGO 1" for the filling line *LIQUID*	94 760	REGO 13740-4	LNG fuel dispenser
Breakaway coupling REGO 1/2" for the return line *VENT*	94 763	REGO 14 370	LNG fuel dispenser
Mounting sleeves for CRYOMAC 3-50	99 811	REGO 14103	CRYOMAC3-50 LNG fuel dispenser
Seal kit for CRYOMAC 3	99 8111	REGO 14255	CRYOMAC LNG fuel dispenser
CRYOMAC3 Interface seal replacement	99 8112	REGO 14591	CRYOMAC LNG fuel dispenser
Gasket changing nozzle CRYOMAC3	99 8113	REGO 14590	CRYOMAC LNG dispenser
End kit for CRYOMAC3	99 8114	REGO 13960	CRYOMAC LNG dispenser
Mounting elements for replacing the end caps Cryomac3	998115	REGO T-2961	CRYOMAC LNG dispenser
Copper gaskets for LNG hose	99 8124	REGO 10719-10	CRYOMAC LNG dispenser
Copper gaskets for LNG hose	99 8125	REGO 10719-16	CRYOMAC LNG dispenser
Seal kit for Quick Disconnect Vent Female	99 812	REGO 11093	Quick disconnect Female Vent LNG dispenser
Poppet assembly for Quick Disconnect Vent Female	99 8121	REGO 14 535	Quick disconnect Female Vent LNG dispenser
Body Seal for for Quick Disconnect Vent Female/Male	99 8122	REGO 11173	Quick disconnect Female/Male Vent LNG dispenser
Vent Thread Ring Tool	99 8123	REGO T-1948	Quick disconnect Female Vent LNG dispenser
Copper gaskets for LNG hose	99 8124	REGO 107109-09	For 1/2" LNG hose
Copper gaskets for LNG hose	99 8125	REGO 107109-16	For 1" LNG hose
LNG 1" liquid phase hose 3 m	94 690	CHS-8-514-514-120MXS	LNG regasification dispenser
LNG 1" liquid phase hose 3,6 m	94 691	CHS-8-514-514-144MXS	LNG regasification dispenser
LNG 1" liquid phase hose 3,90 m	94 692	CHS-8-514-514-156MXS	LNG regasification dispenser
LNG 1" liquid phase hose 4,50 m	94 693	CHS-8-514-514-180MXS	LNG regasification dispenser
LNG 1" liquid phase hose 5 m	94 698	CHS-8-514-514-197MXS	LNG regasification dispenser
LNG 1" liquid phase hose 6 m	94 699	CHS-8-514-514-240MXS	LNG regasification dispenser
LNG 1/2" vapour phase hose 1,2 m	94 681	CHS-4-440-440-048M	LNG regasification dispenser
LNG 1/2" vapour phase hose 1,5 m	94 682	CHS-4-440-440-060M	LNG dispenser
LNG 1/2" vapour phase hose 1,8 m	94 683	CHS-4-440-440-072M	LNG dispenser
LNG 1/2" vapour phase hose 2,4 m	94 684	CHS-4-440-440-96M	LNG dispenser
LNG 1/2" vapour phase hose 3 m	94 685	CHS-4-440-440-120M	LNG dispenser
LNG 1/2" vapour phase hose 3,6 m	94 686	CHS-4-440-440-144M	LNG dispenser
LNG 1/2" vapour phase hose 5 m	94 687	CHS-4-440-440-197M	LNG dispenser
LNG 1/2" vapour phase hose 6 m	94 688	CHS-4-440-440-240M	LNG dispenser
LNG 1/2" vapour phase hose 20 m	94 6881	CHS-4-440-440-787M	LNG dispenser

# REGO®

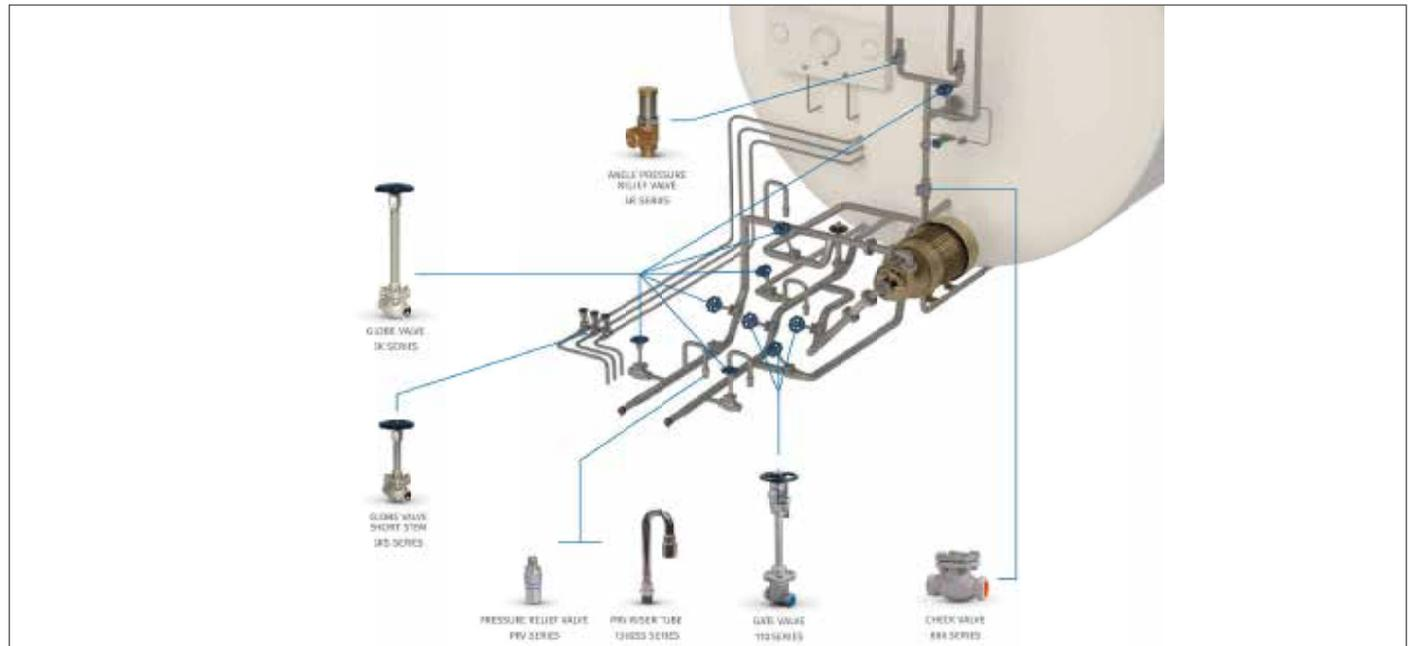
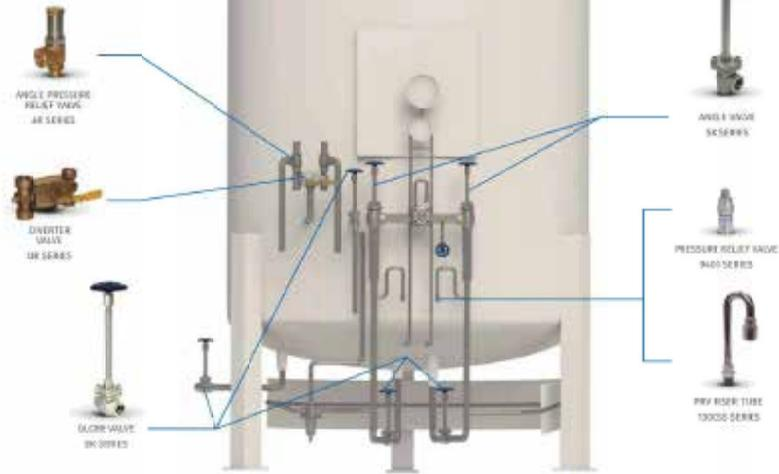

# Cryogenic & Industrial Gas Products **REGO**

## Cryogenic Cylinder Equipment Rego

- T9450 Series & T9460 Series
- ES8450, BK9450 & BK9470
- RegO® LOK™
- RG Series
- ECL Series
- CBH & CBC Series
- LCR Series



## Gate Valves

- 322 & 326 Series
- 302, 306, 310 & 310X Series
- 110 Series



## Master High Pressure Valves

- HP9560 Series
- 7160 Series



## Relief Valves

- 9400 Series
- PRV 19430 & PRV 29430
- NR/AR/DR/DA Series
- UA 3149A Series
- Brass Pipe Caps
- B-19434B Series & C-19434B Series



## Check Valves

- 8500 Series
- 846M & 840 Series
- 886 Series
- CG Series
- NG Series



## Adapters, Nipples, Pipe & Miscellaneous

- Pressure Gauges
- CMM 250 Series and CFF 250 Series
- Brass Adapters



## Globe Valves

- BB Series
- 222 226LL 226GF 226ULL 226BLC Series
- 202X 206LL 206GF 206ULL 206BLL Series
- SK Series
- 210 Series
- 231 Series
- 232 Series
- CFM, AFM & SFM Series
- 2550 Series
- 2500 Series



## Regulators

- 1780 Series
- BR-1780 Series
- 1682M Series & C-1682M Series
- M2523HP Series
- 4403 Series
- 4286-10 Series & 4289-10 Series
- Alarm Gauges 4285-9B
- 4286/4289/4291 Series





## Equipment for use with gases in medical, food and other cryogenic applications



**Series 2400 – safety valves made of stainless steel, angle-type with threaded connections.**

Safety valves are set and sealed at the factory and are oil- and grease-free as standard.

- connections – 1/4-1 1/2"
- temperatures – -200...+200°C
- setting pressure – 0,2...70,0 bar



**Series 2480 – safety valves made of gunmetal, angle-type with threaded connections.**

Safety valves are set and sealed at the factory and are oil- and grease-free as standard.

- connections – 1/4-1"
- temperatures – -200...+200°C
- setting pressure – 0,2...70,0 bar



**Series 2700 – diverter ball valves made of stainless steel with threaded connections.**

For use with gases in medical, food and other cryogenic applications. The ball-valves of this type are oil- and grease-free as standard.

- connections – 3/4-1 1/4"
- temperatures – -200...+200°C
- setting pressure – PN 63



**Series 2580 – overflow valves made of gunmetal, angle-type with threaded connections.**

For use with gases in medical, food and other cryogenic applications. Overflow valves of this type are oil- and grease-free as standard.

- connections – 1/4-1/2"
- temperatures – -200...+200°C
- setting pressure – 0,2...70,0 bar



**Series 2780 – diverter ball valves made of gunmetal with threaded connections.**

For use with gases in medical, food and other cryogenic applications. The ball-valves of this type are oil- and grease-free as standard.

- connections – 3/4-1 1/4"
- temperatures – -200...+200°C
- setting pressure – PN 63

# ALTERNATIVE FUEL FAS

## LNG pipe – vacuum or PUR insulated

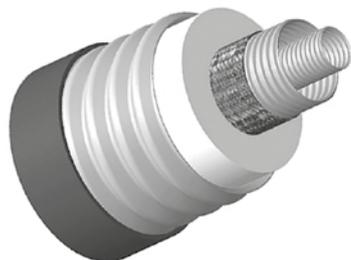

All-in-one PUR – with PUR-foam insulation



All-in-one VIP – the vacuum insulated pipe



The LNG all-in-one pipe consists out of three endless corrugates pipes:

- LNG-supply
- LNG/BOG-return
- the third one also is a corrugated pipe which creates a secondary containment for the LNG and contains the
  - optimized PUR-foam insulation or
  - vacuum superinsulation

### FAS 61 6508 CryoMac® 3 50 GPM LNG Filling Nozzle

- flow capacity – 50 GPM
- JIC male SAE 37° flare fitting for 1" tube – stand
- handle ISO 12617 road vehicles certified
- EX II 2 G c IIA T3

*Certified according to ISO 12617 approved product as specified by ISO 16924  
Natural gas fueling stations – LNG stations for fueling vehicles*

FAS No.	Type	DN 1	DN 2	PN	Ø, "/mm	Volume DN 1 l/m	Volume DN 2 l/m	Weight kg/m	Bending radius, "/MM
<b>All-in-one PUR – with PUR-foam insulation</b>									
48 640	AiO PUR 39-64/148	1¼" DN 32	1¼" DN 32	25	6,0/153	1,35	2,13	8,5	47/1200
48 641	AiO PUR 48-83/171	1½" DN 40	2" DN 50	25	6,9/175	2,00	4,00	12,5	30/1500
<b>All-in-one VIP – vacuum insulated</b>									
48 642	AiO VIP 39-64/115	1¼" DN 32	1¼" DN 32	25	4,6/117	1,35	2,13	7,5	39/1000
48 643	AiO VIP 48-83/152	1½" DN 40	2" DN 50	25	6,0/152	2,00	4,00	11,0	47/1200



# HEROSE

## Equipment for cryogenic applications



### Cryogenic globe valve and globe/check valve HEROSE, type 01 641

- size: 3/8" – 6" (DN 10 – DN 150)
- PN 50 (DN 65 = PN 45, DN 150 = PN 40)
- "Fire safe" type test approval acc. to EN ISO 10497
- approved for air gases, vapours and cryogenic liquefied gases incl. LNG
- working temperature: -196 up to +120°C
- stainless steel body and topwork
- "live loaded" gland packing
- cleaned and degreased for oxygen service
- butt weld and socket weld connection for stainless steel pipes acc. to ISO 1127 or ASTM A312

Type 01 641	Technical Data													
Nominal Size	DN	10	15	15	20	25	32	40	40	50	65	80	100	150
Face-to-face dimension, mm	Overall Length	70	85	85	100	115	115	130	130	155	205	245	280	400
Height, mm		270/370											370	420



### Cryogenic globe valve with pneumatic actuator HEROSE, type 01 643

- size: 3/8" – 6" (DN 10 – DN 150)
- PN 50 (DN 65 = PN 45, DN 150 = PN 40)
- "Fire safe" type test approval acc. to EN ISO 10497
- approved for air gases, vapours and cryogenic liquefied gases incl. LNG
- working temperature: -196 up to +120°C
- stainless steel body and topwork
- "live loaded" gland packing
- cleaned and degreased for oxygen service
- butt weld and socket weld connection for stainless steel pipes acc. to ISO 1127 or ASTM A312

Type 01 643	Technical Data													
Nominal Size	DN	10	15	15	20	25	32	40	40	50	65	80	100	150
Face-to-face dimension, mm	Overall Length	70	85	85	100	115	115	130	130	155	205	245	280	400
Height, mm		370	370	370	370	375	405	420	420	425	510	575	635	685



### Cryogenic globe valve HEROSE, type 01 641, DN 200

In flow direction, the valve with the nominal size DN 200 is conform to tightness class L1 up to 9 bar maximum differential pressure acc. to DIN 12567 for LNG use. This standard can also be used for the tightness class of other cryogenic gases.

- DN 200, PN 25
- "Fire safe" type test approval according to EN ISO 10497
- approved for air gases, vapours and cryogenic liquefied gases, incl. LNG
- working temperature: -196 up to +120°C
- stainless steel body and topwork
- "live loaded" gland packing
- butt weld connection and socket weld connection for stainless steel pipes according to ISO 1127 or ASTM A312

### Cryogenic globe valve with pneumatic actuator HEROSE, type 01 643, DN 200

In flow direction, the valve with the nominal size DN 200 is conform to tightness class L1 up to 18 bar maximum differential pressure acc. to DIN 12567 for LNG use. This standard can also be used for the tightness class of other cryogenic gases.

- DN 200, PN 25
- "Fire safe" type test approval according to EN ISO 10497
- approved for air gases/vapours/cryogenic liquefied gases, incl. LNG
- actuator: air opens, spring closes or contrary
- working temperature: -196 up to +120°C
- stainless steel body and topwork
- "live loaded" gland packing
- butt weld connection and socket weld connection for stainless steel pipes according to ISO 1127 or ASTM A312

Available accessories/options (on request only)

- solenoid valve • limit switch • electropneumatic positioner etc.
- welded stainless steel stubs acc. to ISO 1127 or ASTM A312
- actuator "cleaned and degreased for oxygen service" • valve with check or control disc (tapered design)

Type 01 643	Technical Data	
Nominal Size	DN 200	
Face-to-face dimension, mm	Overall length	560
Height, mm		785



### Cryogenic globe valve and globe/check valve HEROSE, type 01 645

- size: 1/4"-2" (DN 10-DN 150)
- PN 50 (DN 65=PN 45, DN 150=PN 40)
- "Fire safe" type test approval acc. to EN ISO 10497
- approved for air gases, vapours and cryogenic liquefied gases incl. LNG
- working temperature: -196 up to +120°C
- stainless steel body and topwork
- "live loaded" gland packing
- cleaned and degreased for oxygen service
- butt weld and socket weld connection for stainless steel pipes
- acc. to ISO 1127 or ASTM A312

Type 01645	Technical Data									
Nominal Size	DN	10	10	15	20	25	40	40	50	
Thread Size	inch	1/4	3/8	1/2	3/4	1	1 1/4	1 1/2	2	
Face-to-face dimension, mm	Overall Length	70	70	85	100	115	130	130	155	
Height, mm		270/370								



### Cryogenic globe valve and globe/check valve HEROSE, type 01 651

- size: 3/8-4" (DN 10-DN 100)
- PN 50 (DN 65 = PN 45)
- "Fire safe" type test approval acc. to EN ISO 10497
- approved for air gases, vapours and cryogenic liquefied gases incl. LNG
- working temperature: -196 up to +120°C
- recommended working temperature: -60°C up to +120°C

- stainless steel body and topwork
- "live loaded" gland packing
- cleaned and degreased for oxygen service
- butt weld and socket weld connection for stainless steel pipes acc. to ISO 1127 or ASTM A312

Type 01651		Technical Data											
Nominal Size	DN	10	15	15	20	25	32	40	40	50	65	80	100
Face-to face dimension, mm	Overall Length	70	85	85	100	115	115	130	130	155	205	245	280
Height, mm		140	140	140	140	140	170	175	175	200	260	310	350



### Cryogenic globe valve with pneumatic actuator HEROSE, type 01 653

- size 3/4-3" (DN 20-DN 80)
- PN 50 (DN 65 = PN 45)
- "Fire safe" type test approval acc. to EN ISO 10497
- approved for air gases, vapours and cryogenic liquefied gases incl. LNG
- working temperature: -196 up to +120°C
- ambient temperature actuator: -50°C up to +70°C
- air pressure for operation 6.0 bar g (maximum 10.0 barg), push-in connection 8 mm

- stainless steel body and topwork
- actuator – air opens, spring closes
- "live loaded" gland packing
- cleaned and degreased for oxygen service
- the actuator is not cleaned and degreased for oxygen
- maximum working pressure of the valve depending on nominal size
- butt weld and socket weld connection for stainless steel pipes acc. to ISO 1127 or ASTM A312

Type 01 653		Technical Data							
Nominal Size	DN	15	20	20	25	40	50	65	80
Thread Size	inch	1/2	3/4	3/4	1	1 1/2	2	2 1/2	3
Face-to face dimension, mm	Overall Length	85	100	100	115	130	155	205	245
Height, mm		395	443	443	444	441	420	470	500



### Cryogenic globe valve and globe/check valve HEROSE, type 01 655

- size: 1/4-2" (DN 10-DN 50), PN 50
- "Fire safe" type test approval acc. to EN ISO 10497
- approved for air gases, vapours and cryogenic liquefied gases incl. LNG
- working temperature: -196 up to +120°C
- recommended working temperature: -60°C up to +120°C

- stainless steel body and topwork, "live loaded" gland packing
- cleaned and degreased for oxygen service
- butt weld and socket weld connection for stainless steel pipes acc. to ISO 1127 or ASTM A312

Type 01 655		Technical Data							
Nominal Size	DN	10	10	15	20	25	40	40	50
Thread Size	GW	1/4"	3/8"	1/2"	3/4"	1"	1 1/4"	1 1/2"	2"
Face-to face dimension, mm	Overall Length	70	70	85	100	115	130	130	155
Height, mm		140	140	140	140	140	175	175	175



### Cryogenic globe valve and globe/check valve HEROSE, DIN flanges, type 03 641

- size: DN 15-DN 150
- PN 40
- "Fire safe" type test approval acc. to EN ISO 10497
- approved for air gases, vapours and cryogenic liquefied gases incl. LNG
- working temperature: -196 up to +120°C
- stainless steel body and topwork
- "live loaded" gland packing
- cleaned and degreased for oxygen service
- flanged connection acc. to DIN EN 1092-1 PN40

Type 03 641	Technical Data									
Nominal Size	DN	15	20	25	40	50	65	80	100	150
Face-to face dimension, mm	Overall Length	140	150	160	200	230	290	310	350	550
Height, mm	270/370									



### Cryogenic globe valve and globe/check valve HEROSE, ASME flanges, type 03 641

- size: DN 15-DN 150
- PN 40
- "Fire safe" type test approval acc. to EN ISO 10497
- approved for air gases, vapours and cryogenic liquefied gases incl. LNG
- working temperature: -196 up to +120°C
- stainless steel body and topwork
- "live loaded" gland packing
- cleaned and degreased for oxygen service
- flanged connection acc. to ANSI B16.5 class 300

#### Available options (on request only):

- extension H up to 900 mm
- valve with control disc (tapered design)

Type 03 641 ANSI	Technical Data									
Nominal Size	DN	15	20	25	40	50	65	80	100	150
Face-to face dimension, mm	Overall Length	140	150	160	200	230	290	310	350	597
Height, mm	270/370									



### Cryogenic globe valve with pneumatic actuator HEROSE, ANSI flanges class 150, type 03 643

- size: DN 15-DN 150
- "Fire safe" type test approval acc. to EN ISO 10497
- approved for air gases, vapours and cryogenic liquefied gases incl. LNG
- actuator: air opens, spring closes or contrary
- working temperature: -196 up to +120°C
- stainless steel body and topwork
- "live loaded" gland packing
- cleaned and degreased for oxygen service
- the actuator is not cleaned and degreased for oxygen
- flanged connection acc. to ANSI B16.5 class 150

For both executions there are available accessories:

- solenoid valve
- limit switch
- electropneumatic positioner etc.

Available options (on request only):

- actuator – "cleaned and degreased for oxygen service"
- electric actuator
- valve with check disc
- valve with control disc (tapered design)

### Cryogenic globe valve with pneumatic actuator HEROSE, ANSI flanges class 300, type 03 643

- size: DN 15-DN 150
- "Fire safe" type test approval acc. to EN ISO 10497
- approved for air gases, vapours and cryogenic liquefied gases incl. LNG
- actuator: air opens, spring closes or contrary
- working temperature: -196 up to +120°C
- stainless steel body and topwork
- "live loaded" gland packing
- cleaned and degreased for oxygen service
- the actuator is not cleaned and degreased for oxygen
- flanged connection acc. to ANSI B16.5 class 300

Type 03 643 ANSI		Technical Data								
Nominal Size	DN	15	20	25	40	50	65	80	100	150
Face-to face dimension, mm	Overall Length	140	150	160	200	230	290	310	350	577
Height, mm		370	370	375	420	425	510	575	635	685

Type 03 643 ANSI		Technical Data								
Nominal Size	DN	15	20	25	40	50	65	80	100	150
Face-to face dimension, mm	Overall Length	140	150	160	200	230	290	310	350	597
Height, mm		370	370	375	420	425	510	575	635	685



### Cryogenic globe valve with pneumatic actuator HEROSE, DIN flanges, type 03 643

- size: DN 15-DN 150
- PN 40
- "Fire safe" type test approval acc. to EN ISO 10497
- approved for air gases, vapours and cryogenic liquefied gases incl. LNG
- actuator: air opens, spring closes or contrary
- working temperature: -196 up to +120°C
- stainless steel body and topwork
- "live loaded" gland packing
- cleaned and degreased for oxygen service
- the actuator is not cleaned and degreased for oxygen
- flanged connection acc. to ANSI B16.5 class 150

For both executions there are available accessories:

- solenoid valve
- limit switch
- electropneumatic positioner etc.

Available options (on request only):

- actuator – "cleaned and degreased for oxygen service"
- electric actuator
- valve with check disc
- valve with control disc (tapered design)

### Cryogenic globe valve with pneumatic actuator HEROSE, DIN flanges, type 03 643

- size: DN 15-DN 150
- PN 16
- "Fire safe" type test approval acc. to EN ISO 10497
- approved for air gases, vapours and cryogenic liquefied gases incl. LNG
- actuator: air opens, spring closes or contrary
- working temperature: -196 up to +120°C
- stainless steel body and topwork
- "live loaded" gland packing
- cleaned and degreased for oxygen service
- the actuator is not cleaned and degreased for oxygen
- flanged connection acc. to ANSI B16.5 class 150

Type 03 643 DIN fl.		Technical Data								
Nominal size	DN	15	20	25	40	50	65	80	100	150
Face-to-face dimension, mm	Overall Length	140	150	160	200	230	290	310	350	550
	Height, mm	370	370	375	420	425	510	575	635	685

Type 03 643 DIN fl.		Technical Data								
Nominal size	DN	15	20	25	40	50	65	80	100	150
Face-to-face dimension, mm	Overall Length	140	150	160	200	230	295	310	350	510
	Height, mm	370	370	375	420	425	510	575	635	685





### Cryogenic ball valve, extended, type PY4

- size: 1/4"-2" (DN 8-DN 50)
- pressure range:
  - to DN 20 – 100 bar
  - to DN 32 – 70 bar
  - to DN 50 – 50 bar
- temperature range: -196...+190°C.
- stainless steel extended spindle
- 3-piece cryogenic ball valve complete with live loaded packing and pressure relief hole
- cleaned & packed for oxygen service
- options: fire-safe, 3-way valves and end connection

Type PY4, extended	Technical Data								
Nominal size	DN	8	12	15	20	25	32	40	50
Face-to face dimension, mm	Overall length	65	65	70	85	100	110	125	150
Height, mm		226,5	226,5	230	278,9	283	322,5	327,5	345,8



### Cryogenic ball valve, non-extended, type PY4

- size: 2 1/2"-6" (DN 8-DN 150)
- pressure range:
  - to DN 80 – 40 bar
  - to DN 150 (reduced bore only) – 25 bar
- temperature range: -50...+190°C.
- stainless steel non-extended spindle
- 3-piece cryogenic ball valve complete with live loaded packing and pressure relief hole
- cleaned & packed for oxygen service
- options: fire-safe, 3-way valves and end connection

Type PY4, non-extended	Technical Data				
Nominal size	DN	65	80	100	150
Face-to face dimension, mm	Overall length	180	210	230	290
Height, mm		171	182	204	270

### Cryogenic ball valve, non-extended, type PY4

- size: DN 8-DN 50
- pressure range:
  - to DN 20 – 100 bar
  - to DN 32 – 70 bar
  - to DN 50 – 50 bar
- temperature range: -50...+190°C.
- stainless steel non-extended spindle
- 3-piece cryogenic ball valve complete with live loaded packing and pressure relief hole
- cleaned & packed for oxygen service
- options: fire-safe, 3-way valves and end connection

Type PY4, extended	Technical Data								
Nominal size	DN	8	12	15	20	25	32	40	50
Face-to face dimension, mm	Overall length	65	65	70	85	100	110	125	150
Height, mm		70	70	73	91	95	111	116	137

*Options: full and reduced bore, actuation, double block & bleed, fire-safe, 3-way valves and end connection options. Available connections: butt weld, socket weld, BSP/NPT threaded.*





ONE WORLD • ONE TEAM • ALL GASES



**MAKEEN**  
ENERGY



Flüssiggas Anlagen GmbH  
Peiner Str 217 / 38 229  
Salzgitter  
Germany  
Tel +49 5341 8697-0  
web-sales@fas.de  
www.fas.de  
www.makeenenergy.com